

StudioLive™ Series III

AVB Networking Guide

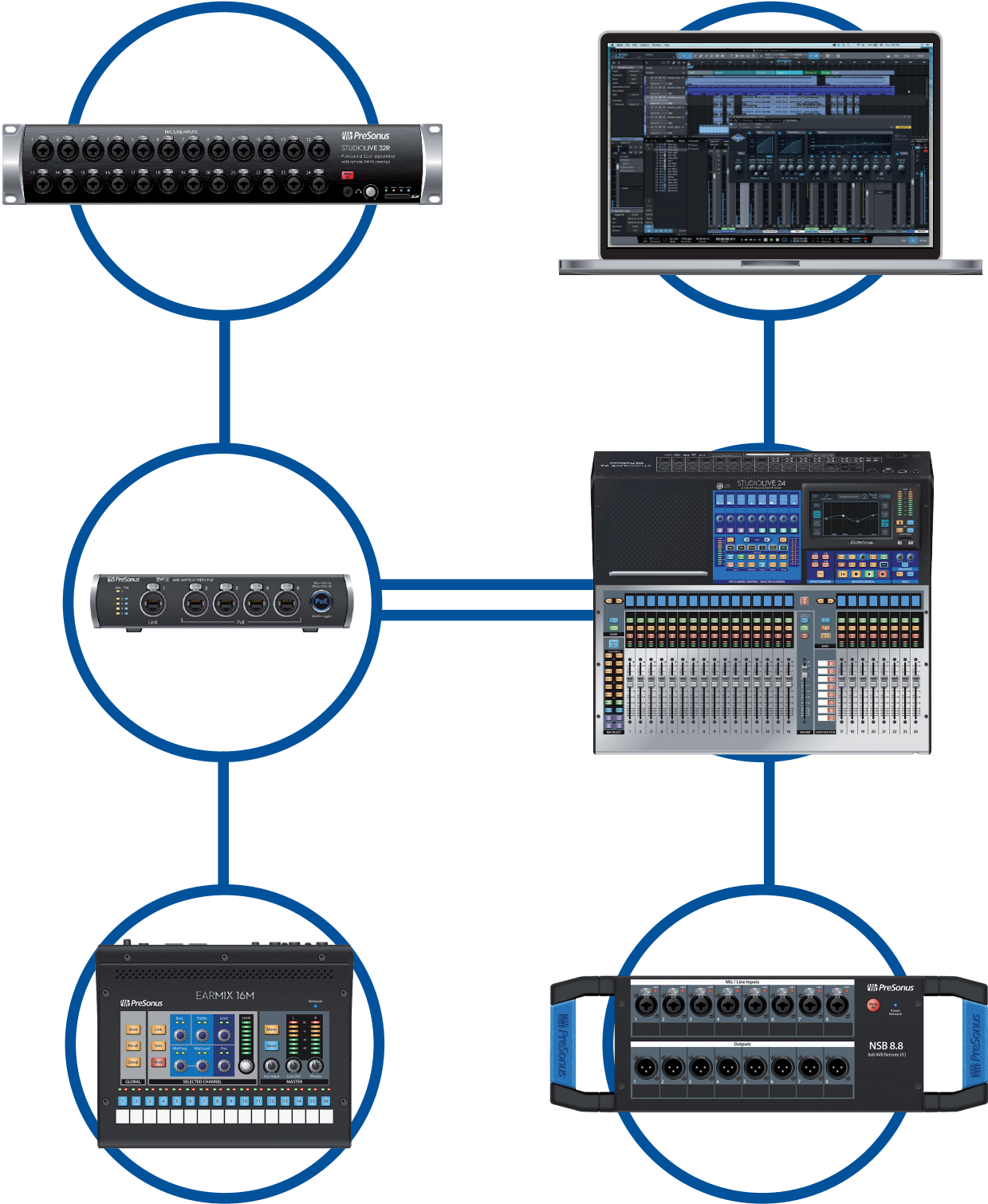

Table of Contents

1 Overview — 1

- 1.1 An Introduction to Audio Networking — 2
- 1.2 Distributed Audio — 2
- 1.3 Network Foundations — 3
- 1.4 Addressing — 3

2 AVB Networking — 4

- 2.1 System Overview — 4
- 2.2 What is AVB? — 5
- 2.3 How Does AVB Work? — 6
- 2.4 AVB Hardware Components — 6
- 2.5 Overcoming Latency — 7
- 2.6 Channels and Streams — 7
- 2.7 Clocking — 8
 - 2.7.1 Wordclock — 8
 - 2.7.2 Precision Time Protocol (PTP) — 9
 - 2.7.3 Multiple Stream Reservation Protocol (MSRP) — 9
 - 2.7.4 Clocking a PreSonus AVB Network — 11

3 AVB Networking Basics — 13

- 3.1 Selecting the Right Switch — 13
 - 3.1.1 PreSonus SW5E AVB Switch with PoE — 13
- 3.2 Adding a Wireless Router — 15
- 3.3 Choosing the Right Cables — 16
 - 3.3.1 Cat5e and Cat6 — 16
 - 3.3.2 Shielded vs. Unshielded — 17
 - 3.3.3 Solid-core vs. Stranded — 18
 - 3.3.4 Plug Termination — 19
 - 3.3.5 T568A or T568B — 19
 - 3.3.6 Twisted Pair Tips — 19

- 3.4 Understanding Hops — 20

3.5 Network Topologies — 21

- 3.5.1 Point-to-Point (P2P) — 21
- 3.5.2 Daisy-Chain — 22
- 3.5.3 Star — 23

4 Configuring Your AVB Network — 24

- 4.1 Using AVB with a StudioLive Series III Mixer and a Mac — 24
 - 4.1.1 What You Will Need — 24
 - 4.1.2 Making the Connections — 24
 - 4.1.3 Setting Up Your Mac — 25
- 4.2 NSB-series Stage Box with a StudioLive Series III Console Mixer — 26
 - 4.2.1 Step 1: Connect Your Stage Box to Your Mixer — 26
 - 4.2.2 Step 2: Routing Stage Box Inputs to Mixer — 28
 - 4.2.3 Step 3: Engage Network Sources — 28
- 4.3 NSB-series Stage Box UC Surface Setup — 29
 - 4.3.1 Step 1: Connect Your Stage Box to Your Mixer — 29
 - 4.3.2 Step 2: Routing Stage Box Inputs to Your Mixer — 30
 - 4.3.3 Step 3: Engage Network Sources — 30
- 4.4 EarMix 16M with StudioLive Console Mixers — 31
- 4.5 EarMix 16M Setup from UC Surface — 32

5 Large Network: Real-world Example — 34

- 5.1 Example Network Overview — 34
- 5.2 Network Connections — 37
 - 5.2.1 Connecting Your Mixers — 39
 - 5.2.2 Connect Your NSB-series Stage Boxes to Your Console Mixers — 41

- 5.3 Analog Input Connections — 44**
 - 5.3.1 Routing AVB Sends to Your Console Mixers — **46**
 - 5.3.2 Routing the NSB-series Inputs to Your StudioLive 24R — **48**
 - 5.3.3 Routing Audio to the Console Mixers — **49**
- 5.4 Analog Output Connections — 51**
 - 5.4.1 Routing the Main Outputs — **51**
 - 5.4.2 Routing Monitor Mixes — **52**
- 5.5 EarMix Setup — 53**
 - 5.5.1 Routing AVB Streams to Your EarMix 16M — **53**
 - 5.5.2 Routing StudioLive 24R Sources to AVB Sends — **54**

1 Overview

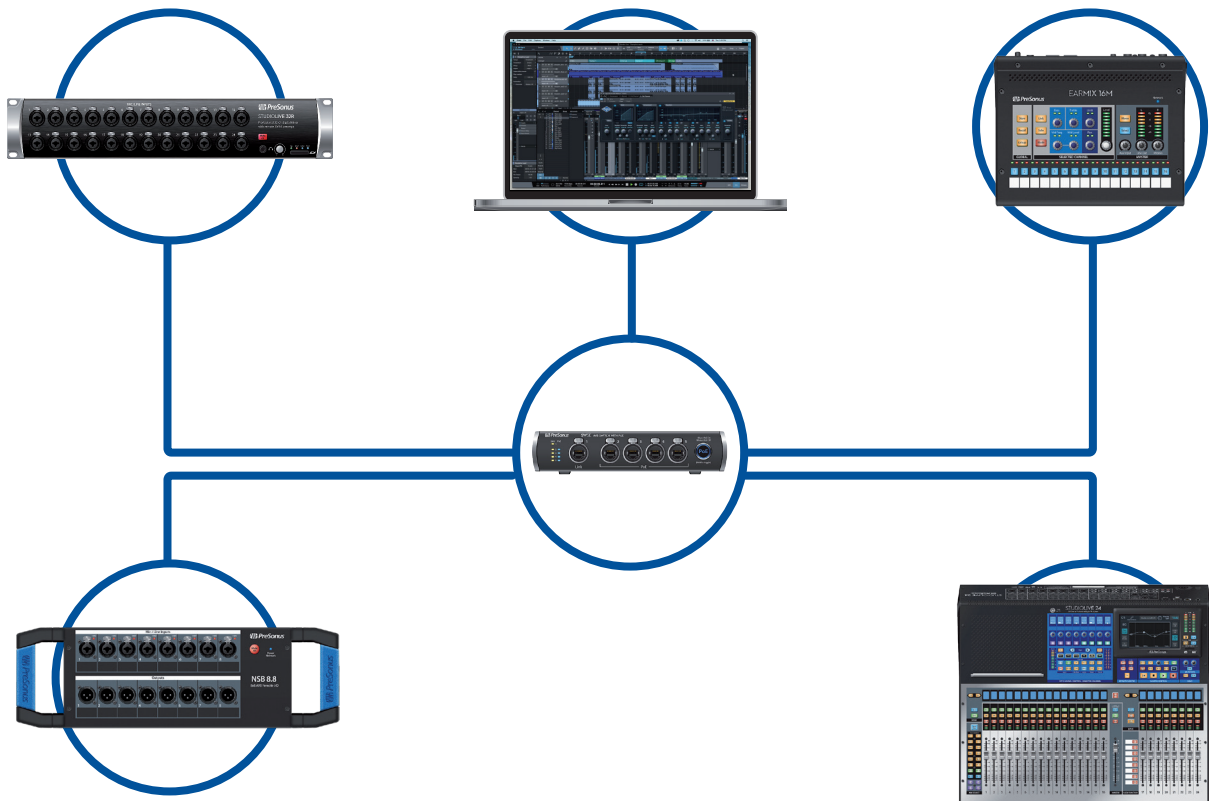

Most people who have used a digital mixer in the last ten years are familiar with incorporating networking technology into their audio application. Remote control over wireless LAN networks, proprietary audio-over-Ethernet protocols, and extensible audio networking platforms have all become relatively commonplace. As networking speed and reliability have increased and the underlying technology has become more affordable, transporting audio over an Ethernet cable can now offer dramatic savings of both time and money, making it more attractive than ever.

While there are several protocols currently in use for audio networking, AVB has many unique benefits that have made it the protocol of choice for the latest generation of PreSonus pro audio equipment. This guide explains the basics of AVB networking as well as best practices and use cases. While this guide covers AVB networking in detail for supported PreSonus products, much of the information here is relevant for other IEEE 1722.1-compliant AVB devices. PreSonus StudioLive Series III mixers are fully compliant with the IEEE 1722.1 standard, which is the protocol for Discovery, Enumeration, Connection management, and Control of AVB devices, also known as AVDECC.

Note: Earlier generations of PreSonus AVB products (StudioLive RM-AI and RML-AI mixers, StudioLive CS18AI, and AI-series consoles equipped with the SL-AVB-MIX option card) are not 1722.1 AVDECC compliant and can only be used with each other. These products are not compatible with IEEE 1722.1 devices like the StudioLive Series III mixers or other third-party AVB products that follow the 1722.1 AVDECC standard.

1.1 An Introduction to Audio Networking

As its name implies, audio networking allows you to transport large amounts of data over a single cable. The bandwidth for modern networking transport protocols is enough to carry hundreds of audio channels without the compression once necessary to do so. This means that audio can be moved quickly over long distances without signal degradation or the expense of conventional analog cabling.

The flexibility demanded by data network protocols also opens up possibilities for audio system configuration that were once impossible. Many nodes of I/O can be placed throughout a facility or venue without the limitations imposed by analog cabling. Because networked audio is digital, electromagnetic interference and cable capacitance that can degrade audio signal quality in the analog domain are no longer problematic.

Because many modern digital audio devices also offer remote control over LAN networks, this also reduces the amount of cabling. In an audio network, control data and audio can travel over the same connection, facilitating flexible routing, preamp control, and more using a single cable.

1.2 Distributed Audio

In a traditional analog system, remote analog I/O must be located within a relatively short distance between the source and the destination. Let's take a common example: the multichannel snake. In a live setting, the stage box to which the musicians are connecting their gear is located with them on stage. This shortens the cable runs coming from multiple locations (e.g., the lead singer's mic, the guitarist's amp, etc.). These cables are connected to a stage box which is attached to a shielded multichannel snake that makes the long run to the mixer at Front-of-House.

In a distributed audio network, each musician could have their own node on the network, potentially. Multiple networked stage boxes can be spread around the stage, making the analog cable runs as short as possible to minimize signal degradation. Take this concept a step further, and multiple sources can be spread throughout a large facility, each sitting on the network to be sent to many mixers on the network, not just the one at front-of-house.

This flexibility makes distributed audio networking an appealing concept for both mobile and installed applications, not only because of the affordability of Ethernet cabling, but because of the ability to customize each system for the people using it.

On the surface, this level of flexibility lends itself to a deeper complexity than a standard analog system. However, when one considers the function of an analog patch bay within a studio setting, audio networking can seem a bit less daunting.

An analog patchbay's purpose is to facilitate the routing of audio. In this way, you can insert your favorite boutique compressor into any channel on your console without rewiring your entire rack. This also lets you route audio from the wall panel in your live room to any preamp you wish to use, audition multiple effects chains, and much more.

The only difference between an analog patchbay and the digital patching available in a distributed audio network is that you must physically trace a cable connection if you are unsure of a particularly complex routing in an analog system. In a distributed audio network, the control panel for all your digital routing allows you to do the same thing from a single screen.

1.3 Network Foundations

No matter what protocol is used, an Ethernet-based audio network will consist of the following:

- **Network Interface Controller (NIC).** These are built into a computer, digital mixer, networked stage box, etc. and, as their name implies, allows these devices to communicate with other devices on a digital network.
- **Ethernet Cables.** Both data and audio networks rely on a set of standards for cabling infrastructure to ensure that network performance is both reliable and consistent. These standards include specifications for the cable construction itself, as well as specifications for the termination of cabling and physical connections to devices. More information on cabling can be found in **Section 4.4**.
- **Switches.** These devices bring all the cables together into a central hub and enable the correct routing of information throughout the network.

1.4 Addressing

Every Network Interface Controller (NIC) on the network must have an address so that the switches know where to send the data packets appropriately. Every NIC must have a Media Access Control (MAC) address programmed by the manufacturer. Every MAC address is unique, and the allocation of MAC addresses to networking manufacturers is strictly managed by the IEEE standards organization.

In addition to a device's MAC address, every NIC has a user-definable addressing layer to make it easier for network managers to configure their local network. Called the Internet Protocol or 'IP' address, this is normally 4 bytes long (IPv4) consisting of the network number and a host address. The division between the two is also 4 bytes long and called the subnet mask.

Every bit in the IP address that has the number 1 in the subnet mask belongs to the same network number. Every bit that has the number 0 belongs to the host address. Where things get tricky is that only NICs with the same network number can exchange data with one another.

If you've ever glanced at the network settings on your personal computer, some of this may seem familiar to you. The operating system on your computer displays the IP and subnet values as four decimal number (0-255). These numbers correspond to the four bytes in the IP address and subnet mask. If we use the example of a small office network, the subnet mask usually has a default value of 255.255.255.0. This provides the network administrator with 255 host addresses to use because only the last byte can be changed when it is assigned to devices on the network (255.255.255.1, 255.255.255.13, etc.). For networks that require more than 255 host addresses, the subnet mask can be changed to accommodate more devices.

The IP addresses can be programmed manually for systems that require it, but in many cases, a central device, such as a router, will automatically assign an IP address whenever a NIC is connected or reconnected. This automatic IP assignment is accomplished using the Dynamic Host Configuration Protocol (DHCP).

StudioLive mixers support DHCP, self-assigned IP addressing, as well as manually assigned addressing. This provides network administrators with the most flexibility when designing a system that includes StudioLive mixers. *For more information, please review the StudioLive Series III Owners Manual.*

2 AVB Networking

2.1 System Overview

AVB networks behave very much like an analog audio system. Like an analog audio system, audio networks consist of sources, destinations, and intermediate processing along the way.

Let's look at a simple live-sound setup:

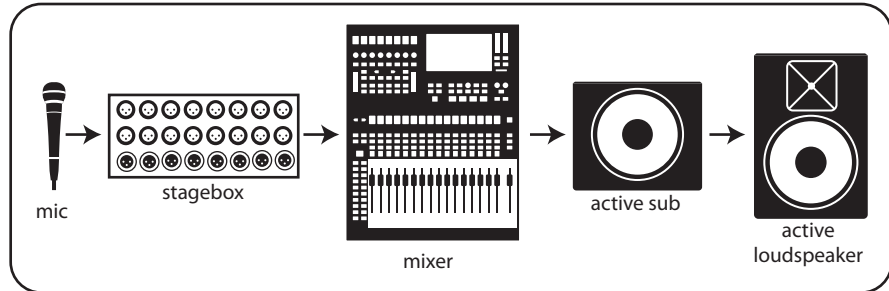

In the above example, an audio signal goes out of the microphone and into the stage box. It then goes to the mixer, where the microphone signal is amplified, routed to the appropriate output, and sent to an active subwoofer, where it is finally passed through to the full-range loudspeaker. All of this is readily apparent to any audio engineer just by looking at the diagram—a good thing because the skills required to configure an analog system are nearly identical those needed by a network engineer.

Let's compare the audio system above with components in a network:

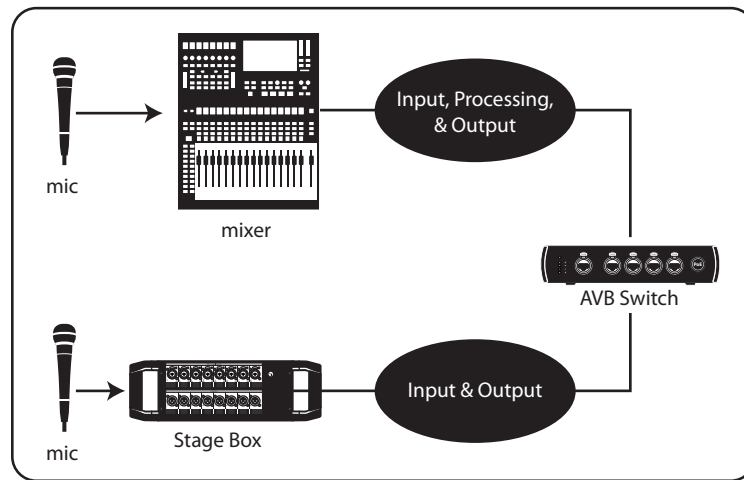

In our network example, the microphones connected to the mixer and stagebox can be freely available on either or both, depending on the routing.

Let's take a quick look at a microphone signal's signal flow on a simple AVB network. In the example below, the microphone's signal is represented by the blue line:

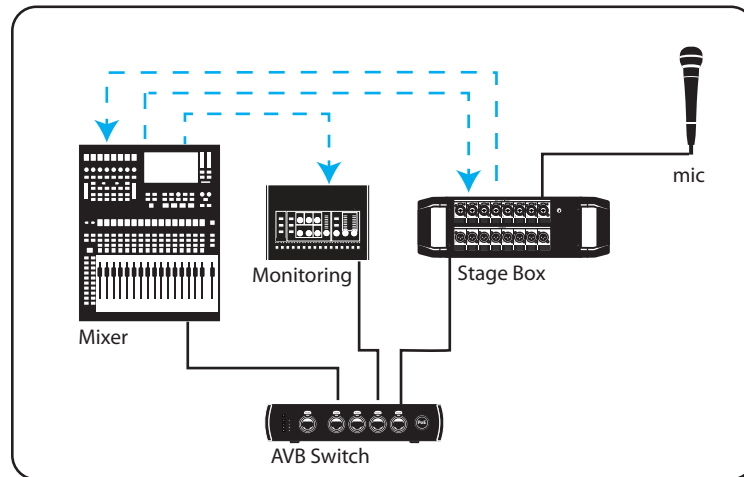

As you can see, tracing a device's signal path becomes a little more complex because the routing is handled entirely in the digital domain. But because experienced audio engineers understand signal flow and are used to troubleshooting problems in an analog system at the various points of weakness, configuring an audio network becomes that much easier.

2.2 What is AVB?

AVB (Audio Video Bridging) is an extension to the Ethernet standard designed to provide guaranteed quality of service, which simply means that audio samples will reach their destinations on time. AVB allows you to create a single network for audio, video, and other data like control information, using an AVB-compatible switch. This enables you to mix normal network data and audio network data on the same network, making it easier to create both simple and complex networks. Numerous audio companies have adopted it, and more companies are adding it all the time.

Audio-over-Ethernet has become increasingly attractive in Pro Audio applications especially for distribution in large-scale systems, such as those used in sporting venues, concert halls, and education institutions. The problem is that most solutions are proprietary, making these systems too expensive and too complex for most smaller applications. AVB is intended to change that by providing an open source collection of IEEE standards available for use by the pro audio market and its manufacturing community.

AVB networking offers several features that make it ideal for audio applications:

- **Long, light cable runs.** A single lightweight CAT5e or CAT6 cable can be run up to 100 meters (328 feet). This makes it easy to have audio I/O located in different rooms (or even different venues in the same building) and run multichannel audio between them in real time.
- **Low, predictable latency.** AVB provides latency of no longer than 2 ms sending an audio stream point-to-point over up to seven "hops" (trips through switches or other devices) on a 100 Mbps network. With higher speed networks, many AVB devices support lower latencies and additional hops.

Please note that while PreSonus AVB products operate at faster Gigabit network speeds, they are currently fixed to 2 ms of latency.

- **Scalable, with high channel counts.** AVB's bandwidth is sufficient to carry hundreds of real-time channels using a single Ethernet cable. This offers the future possibility of expanding your system with additional devices that contain different kinds of audio I/O, multiple controllers, and other useful functions.

- **Guaranteed bandwidth.** AVB networks intelligently manage the data traffic giving priority to AVB data. This means standard network traffic, such as Internet streaming, won't prevent your audio from being delivered reliably and on time.
- **Integrated clock signal.** In a digital audio system with multiple devices, having a master clock is critical to maintaining audio fidelity. The AVB specification defines such a clock to be accurately distributed to all devices in the system.

2.3 How Does AVB Work?

On the simplest level, AVB works by reserving a portion of the available Ethernet bandwidth for its own traffic. Because packets of AVB data are sent regularly in allocated slots within the reserved bandwidth, there are no interruptions or interference, making AVB extremely reliable.

What makes AVB ideal for audio networking is that it splits network traffic into real-time traffic and everything else. All real-time traffic is transmitted on an 8 kHz pulse. Anything that's not real-time traffic is then transmitted around that pulse. Every 125 μ s, all real-time streams send their data. Other packets are transmitted when there is no more real-time data ready to be transmitted. To make sure that there is enough bandwidth available for all prioritized real-time traffic, the Stream Reservation Protocol (SRP, IEEE 802.1Qat) is used.

Every AVB compliant switch between each talker and listener will then make sure sufficient bandwidth is available using SRP, making it a foundational building block of the AVB standard. Every switch and AVB device on the network must implement SRP and send real-time traffic at the 8 kHz pulse. If one of the devices on the network does not employ this standard, then real-time traffic could be potentially delayed, causing jitter in the output.

2.4 AVB Hardware Components

In an AVB network, every device to and from which audio is flowing must adhere to the AVB standard. These devices consist of the following types:

- **AVB Talkers.** These devices act as the source for an AVB stream, sending out audio onto the network.
- **AVB Listeners.** These devices are the destinations for the streams sent out by the Talkers.
- **AVB Switches.** This is the network hub to which every Talker and Listener must be connected. At its most basic level, an AVB Switch analyzes and prioritizes traffic on the network. It should be noted that just like there can be multiple talkers and listeners on the same AVB network, there can also be multiple AVB Switches.
- **AVB Controllers.** A controller can be a talker, a listener, or neither. These devices handle routing, clock, and other settings for AVB devices using AVDECC.

The most important rule to keep in mind when setting up an AVB network is that the talker (device sending audio) and listener (device receiving audio) must be connected to an AVB-compatible switch. All the AVB devices on the network must share a virtual clock that defines when the AVB packet should be played.

As previously mentioned, devices communicate on an AVB network as "talkers" and "listeners." An AVB talker transmits one or more audio streams to the network. AVB listeners receive one or more of these streams from the network. It should be noted that an AVB device, like the StudioLive Series III mixers and NSB-series stage boxes, can be both a talker and a listener. For example, StudioLive 32 can simultaneously "Talk" (send channels out to the network) and "Listen" (receive channels from the network).

AVB devices stay in sync by selecting the best master PTP clock after the devices connect with one another. This ensures that every AVB device on the network will maintain precise timing, which is critical to audio quality.

The AVB switch guarantees that real-time audio data packets maintain their timing without losing information. AVB switches do this by allowing a maximum of 75% of each port to be used for AVB traffic. This prevents non-AVB data from being delayed or lost.

When an AVB network is configured, the Talkers and Listeners identify one another automatically.

2.5 Overcoming Latency

SRP works with the 802.1Qav Queuing and Forwarding Protocol (Qav) to ensure that once bandwidth is reserved for an AVB stream, it is locked down from end to end. Qav schedule time-sensitive streaming information to minimize latency. Together, SRP and Qav make sure that all reserved media streams are delivered on time.

In this way, the AVB network has some intelligence as to how much non-media traffic as well as how many media packets are on the system at any given time. This means that on an AVB network, the worst case travel time is known throughout the entire system. Because of this, only a small amount of buffering is needed, lowering latency to 2 ms over seven switch hops on a 100 Mbps Ethernet network. On gigabit networks, even lower latencies can be achieved.

2.6 Channels and Streams

AVB Streams can be thought of as the pipeline that carries a predefined number of channels between two or more AVB devices. In a PreSonus StudioLive Series III mixer, for example, there are seven input streams and seven output streams available, each carrying eight channels.

It should be noted that each stream can carry any combination of eight channels. The source for the eight channels within each AVB Send stream can be freely routed from any input channel or bus on a StudioLive Series III mixer via the Digital Patching menu. ***For complete information on Digital Patching, please refer to the StudioLive Series III Owners Manual and UC Surface Reference Manual.***

AVB STREAM

Channel 1
Channel 2
Channel 3
Channel 4
Channel 5
Channel 6
Channel 7
Channel 8

In addition to audio channels, each stream can carry clocking information from the network's global clock. Like all digital systems, devices on an AVB network must receive media clock from a master source to maintain proper sync.

2.7 Clocking

All the audio traffic on an AVB network is synchronized using a global clock so that audio can be played and recorded while remaining in time from multiple sources. Obviously, the more audio traffic on a network, the more critical this becomes. For users familiar with traditional digital audio devices (ADAT, S/PDIF, etc.) the idea of a global clocking device will not seem unfamiliar. PreSonus AVB devices have two clocks: one wordclock and one PTP clock.

All AVB devices on the network are synchronized to a common reference time using the IEEE 802.1AS Precision Time Protocol (PTP). Each stream includes a presentation time that all the devices in the network use to align their playback by comparing the presentation time in each stream packet. An advantage to this design is that AVB networking supports multiple simultaneous sample rates and sample clock sources which is important for applications where audio and video need to be synchronized, even though they travel along different paths with different sample rates.

2.7.1 Wordclock

Analog audio is transferred through a cable as a continuous electrical waveform at almost the speed of light. Because of this, audio signal traveling from one analog audio device to another arrives nearly instantaneously, for all practical purposes. Therefore, you don't have to synchronize analog audio passing from one analog device to other analog devices.

Transferring digital audio is a very different matter. Computers and other digital devices operate one step at a time, which happens very quickly but it's not instantaneous, and digital signals are not inherently in perfect time. While uncompressed digital audio plays at a fixed rate (i.e., the sampling frequency), digital clocks are not perfect; their frequency can drift, and they almost always have at least some irregular errors, known as jitter. Therefore, two devices, each following its own clock, are highly unlikely to stay in agreement about precisely when a sample starts and ends. The result is usually an artifact, like a pop or a glitch in the audio.

To avoid this problem, all digital devices in communication with one another need to follow a single master clock. That means the master clock must send a signal that essentially says, "everyone start at this moment and follow me!"

Even if the master clock's timing is imperfect, all the slave devices will follow the timing errors exactly and will stay in sync with each other, eliminating timing-related artifacts. In general, the better the master clock, the better the resulting audio will sound, so whenever possible, use the best clock you have, or experiment with your rig to find the best result.

Whenever digital audio devices are synchronized, it is necessary to designate one device as the "master" wordclock device to which all other digital devices are synced, or "slaved." Once you've determined which device is to be your master clock, you will need to sync the remaining digital devices.

The problem of designating a master wordclock is not handled by AVB and must be set with an AVB controller. Depending on the device, this can be done manually, by the user, or managed automatically. For example, when setting up a StudioLive rack mixer as a stage box from a StudioLive console mixer, the rack mixer is automatically setup to slave from the console mixer's media clock.

Multiple unrelated wordclocks can co-exist on an AVB network. While there are a few ways to match wordclocks between a talker and listener, PreSonus AVB devices currently only support recovering the media clock by listening to the first AVB stream.

2.7.2 Precision Time Protocol (PTP)

Precision Time Protocol or PTP is used to synchronize clocks throughout a computer network. PTP is capable of achieving clock accuracy in the sub-microsecond range, making it suitable for local area networks that require tight timing. Similar to wordclock, PTP uses a master-slave architecture for clock distribution. This protocol defines clock master, link delay and network queuing (both measurement and compensation), as well as clock-rate matching and adjustments for Layer 2 network devices.

In this architecture, there are several different clock types:

- **Ordinary Clock.** This is a device with a single network connection and either the sync source (master) or the sync destination (slave).
- **Boundary Clock.** This device has multiple network connections and can accurately synchronize one network segment to another. A master clock is selected for each segment in the system using a root timing reference generated by the grandmaster clock. The grandmaster sends synchronization information to the all the clocks on its network segment. The boundary clocks on that segment then send accurate time to other network segments to which they're connected. Every AVB Talker is required to be capable of functioning as the grandmaster; however any network node can be the grandmaster, as long as it can either source or derive timing from a grandmaster-capable device.

On an AVB network, PTP generates timestamps so that every listener knows when to playback the audio from the talker. In other words, the PTP clock is used to align audio samples from multiple sources in time. Each grandmaster-capable device broadcasts its clocking using announce messages. The best master clock is then selected from the available announce messages.

2.7.3 Multiple Stream Reservation Protocol (MSRP)

Multiple Stream Reservation Protocol (MSRP) is the IEEE standard used to reserve stream bandwidth for audio on an AVB network. This allows endpoints to automatically route data and reserve bandwidth and eliminates the need for the user to manually configure Quality of Service (QoS) across network devices. MSRP looks at the end-to-end bandwidth that is currently available before an audio stream is sent out. It then reserves a maximum of 75% of the total bandwidth available on that AVB switch's port. If the bandwidth is available, it is locked down along the entire data path, from the Talker, out to every assigned Listener until it is released.

Bandwidth reservations are made based on talker and listener declarations on the switch ports. Talker declarations come in several forms:

- **Advertise Declaration.** This declaration announces that a stream doesn't have any bandwidth or network constraints on its designated path. This means that any destined Listener can create a reservation for QoS. Talkers advertise messages contain all the information necessary to make the reservation.
- **Failed Declaration.** As its name indicates, this announces that a stream is not available to a Listener because the necessary bandwidth is not available or because of other limitations somewhere in the network path between the Talker and the destined Listener.

As mentioned earlier, Listeners also make declarations within an AVB network. These consist of the following types:

- **Ready.** One or more Listeners are requesting a stream and sufficient bandwidth and resources are available from the Talker along the network path to every intended Listener.
- **Ready Fail.** In this instance, one or more Listeners are requesting a stream, but not all of them have sufficient bandwidth and resources on the path to the Talker. In other words, at least one Listener has encountered an obstacle and at least one Listener has not.

- **Fail.** When a Fail declaration is sent, one or more Listener has requested a stream and every Listener that has done so does not have sufficient bandwidth or resources in the network path to attach to the desired stream.

End-to-end stream reservation is successful as soon as the Listener receives the Talker's Advertise Declaration and the Talker receives the Listener's Ready Declaration.

AVB stream reservation process:

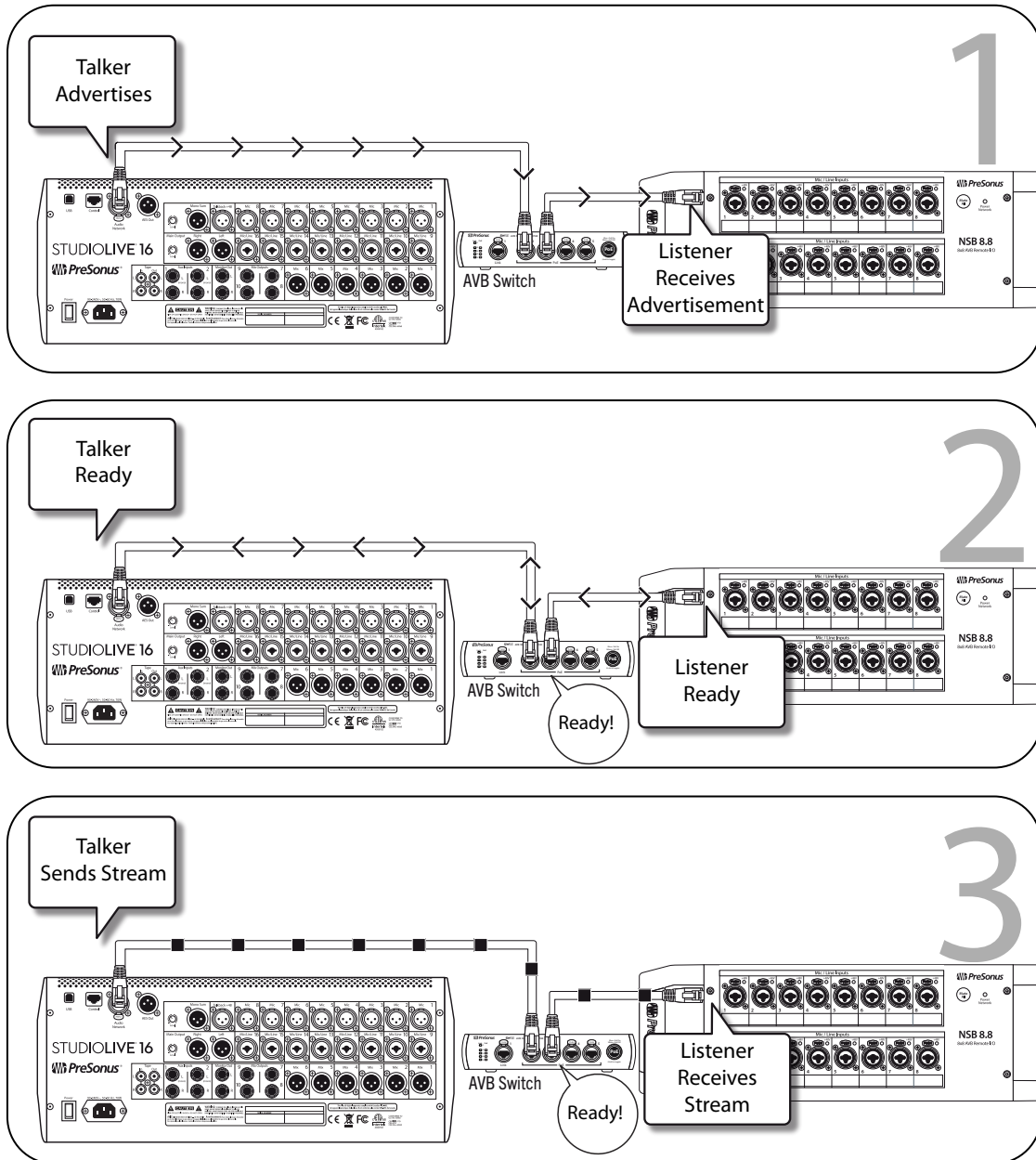

AVB streams are only forwarded once a successful reservation is made. After the streams stop, switch resources are then released and the process can begin again or make room for other network traffic. In this way, the AVB standard ensures that audio data streams always have the highest QoS and all other data is secondary or tertiary.

2.7.4 Clocking a PreSonus AVB Network

Within the PreSonus AVB ecosystem, a StudioLive Series III mixer must be used the master word clock for the network. For some devices, clocking is handled automatically. For others, additional set-up is required. This section will provide an overview of the steps required for proper system clocking.

EarMix 16M Personal Monitor Mixers

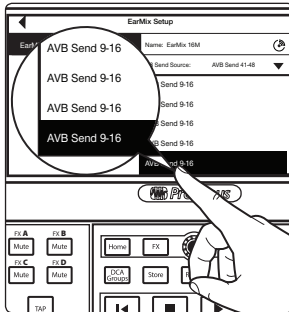

Because the EarMix 16M is a listener only, it defaults to clocking from the incoming audio streams. As soon as you route an AVB Send to your EarMix 16M, it will sync to the master mixer.

NSB-Series Stage Boxes

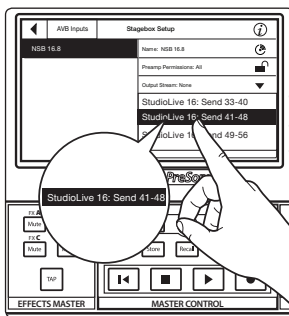

NSB-Series stage boxes are designed to provide both remote inputs and remote outputs for StudioLive Series III mixers. Like the EarMix 16M, the NSB-series stage boxes will default to external clock and sync to a StudioLive Series III mixer as soon as AVB sends are routed to their outputs.

It is important to note that these AVB sends must be routed whether they are needed or not. Let's look at the common example of a StudioLive 16 console mixer with two NSB 8.8 stage boxes. In some situations, the eight outputs on the second NSB 8.8 stage box may not be needed to pass audio. In this case, routing an AVB output stream from the mixer to the stage box would still be required for proper clocking.

StudioLive Series III Mixers (Monitor Mixer Mode)



StudioLive Series III mixers provide a customized mode when used as Monitor mixer. This mode allows them to retain independent control over their FlexMix outputs while sharing input streams as well as the Main Mix with the Front-of-House mixer. As soon as Monitor Mixer Mode is engaged on a StudioLive Series III rack mixer, its clock is set to sync to the Front-of-House console as well. No further set-up is required.

StudioLive Series III Rack Mixers (Stagebox Mode)

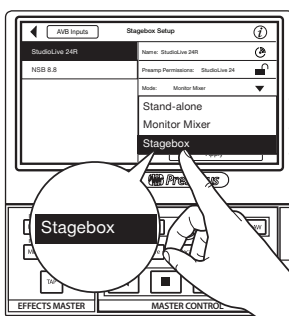

StudioLive Series III rack mixers also provide a customized mode to function as a stage box for other StudioLive mixers. This mode allows them to share all their inputs and outputs with the Front-of-House mixer, effectively disabling all DSP functionality. As soon as Stagebox Mode is engaged on a StudioLive Series III rack mixer, its clock is set to sync to the Front-of-House console as well. No further set-up is required.

StudioLive Series III Mixers (Standalone Mode)

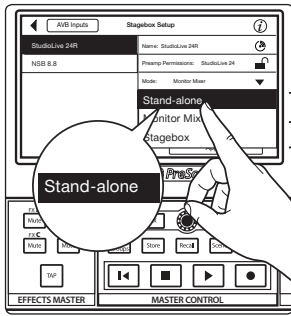

In applications where two or more mixers are on a network, functioning independently, but configured to send and received streams to and from other AVB nodes on the network, you must designate one mixer as the clock master.

To do this, simply set all other mixers to receive clock from the Network Stream and be sure a stream is routed to the first AVB stream of each mixer from the master mixer. Be sure to leave one mixer on its Internal clock.

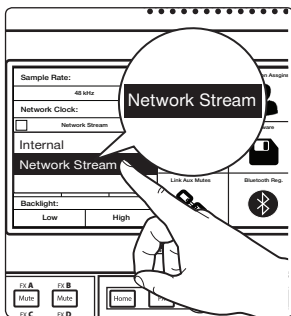

On a StudioLive Series III console mixer, configuring external clocking can be done from the System Menu located on the Home Screen.

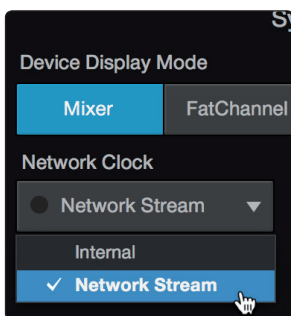

On all StudioLive Series III mixers (rack or console), configuring external clocking can be done from the Device Settings Menu in UC Surface.

3 AVB Networking Basics

When configuring an AVB network, it is important to familiarize yourself with the fundamental components. This section has been designed to assist you in building your AVB network from the ground up.

3.1 Selecting the Right Switch

By definition, all AVB switches must adhere to every IEEE standard within the AVB protocol. Ordinary LAN switches (managed or unmanaged) used in everyday IT applications don't have this same requirement and do not support the protocols necessary for AVB networking.

All AVB switches are required to support the following:

- **IEEE 802.1Q:** Stream Reservation Protocol (SRP) and Traffic Shaping (FQTSS)
- **IEEE 802.1AS:** Time Synchronization using Generalized Precision Time Protocol (gPTP) on each AVB enabled Ethernet port

These standards are critical for both reservation management and tight, synchronized clocking.

3.1.1 PreSonus SW5E AVB Switch with PoE

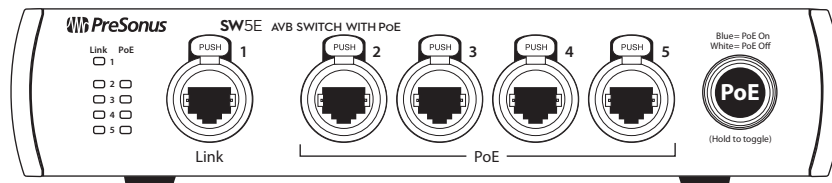

The PreSonus SW5E AVB Switch with PoE is a 5-port AVB switch that is fully compatible with all PreSonus AVB devices. In addition to adhering to the required IEEE standards, the SW5E provides Power over Ethernet (PoE) on four of its five ports.

Power over Ethernet or PoE is an IEEE standard that allows electric power to be provided over the same Ethernet cable used for data transfer, similar to how Phantom Power provides enough current over an XLR cable to power condenser microphones and active direct boxes.

The PreSonus EarMix 16M can be fully powered by PoE using a PreSonus SW5E switch or any other standard AVB switch that provides it. It should be noted that while the EarMix 16M can receive PoE, it does not pass that power through to other devices. So, in order to power multiple EarMix 16M, each mixer must have a direct path back to a PoE AVB Switch.

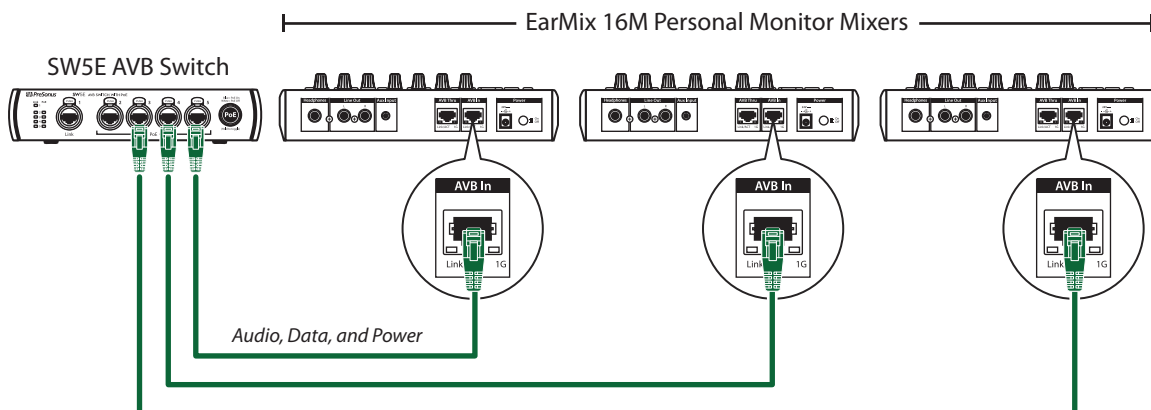

In situations where this is not possible, an external power supply may be used to power each EarMix 16M. This also allows you to daisy-chain multiple units to a single port on your AVB switch.

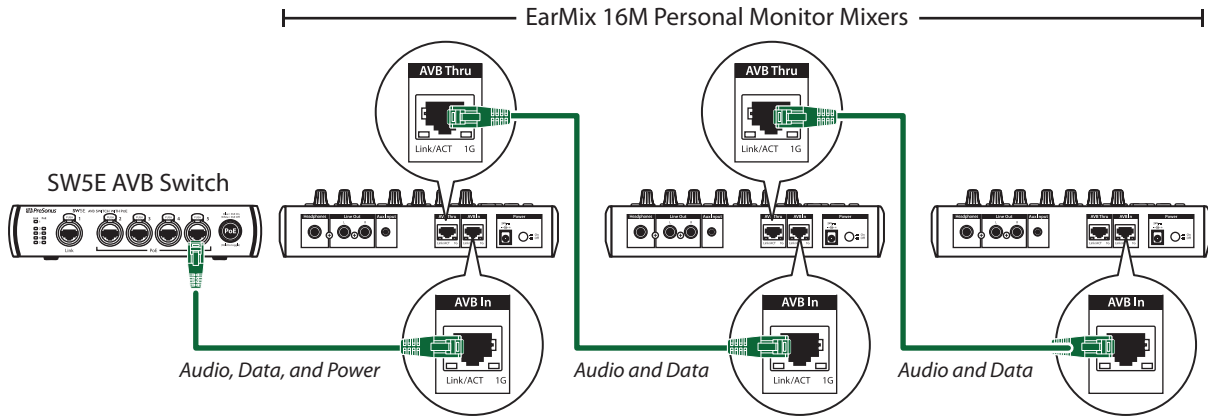

3.2 Adding a Wireless Router

Many modern digital audio devices support some level of control over a Local Area Network. Unlike its AVB counterpart, a standard LAN network does not prioritize the traffic on it. While this is fine for control information and other simple data, it is less than ideal for transmitting low-latency audio. PreSonus StudioLive Series III mixers support both AVB and LAN networking, each with its own dedicated Ethernet port.

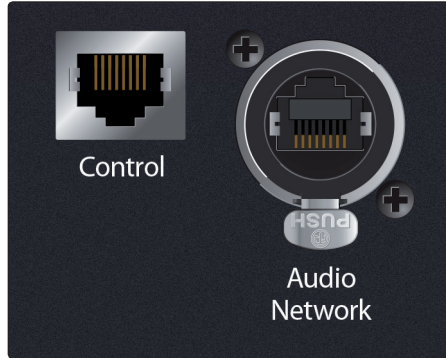

For StudioLive Series III mixers, the Audio Network connection should attach to the AVB network, while the control port should be connected to a wireless router, or an access point, so that the mixer can be controlled remotely from UC Surface or QMix-UC. The control port should also be used to network your mixer to your computer while using DAW mode.

It should be noted that while a wireless router can be connected to an AVB switch, you would still need to connect both the Audio Network and the Control port to a network configured in this manner. Because of this, PreSonus recommends that you create two networks for your StudioLive mixer: one dedicated to control data and a second dedicated to AVB data.

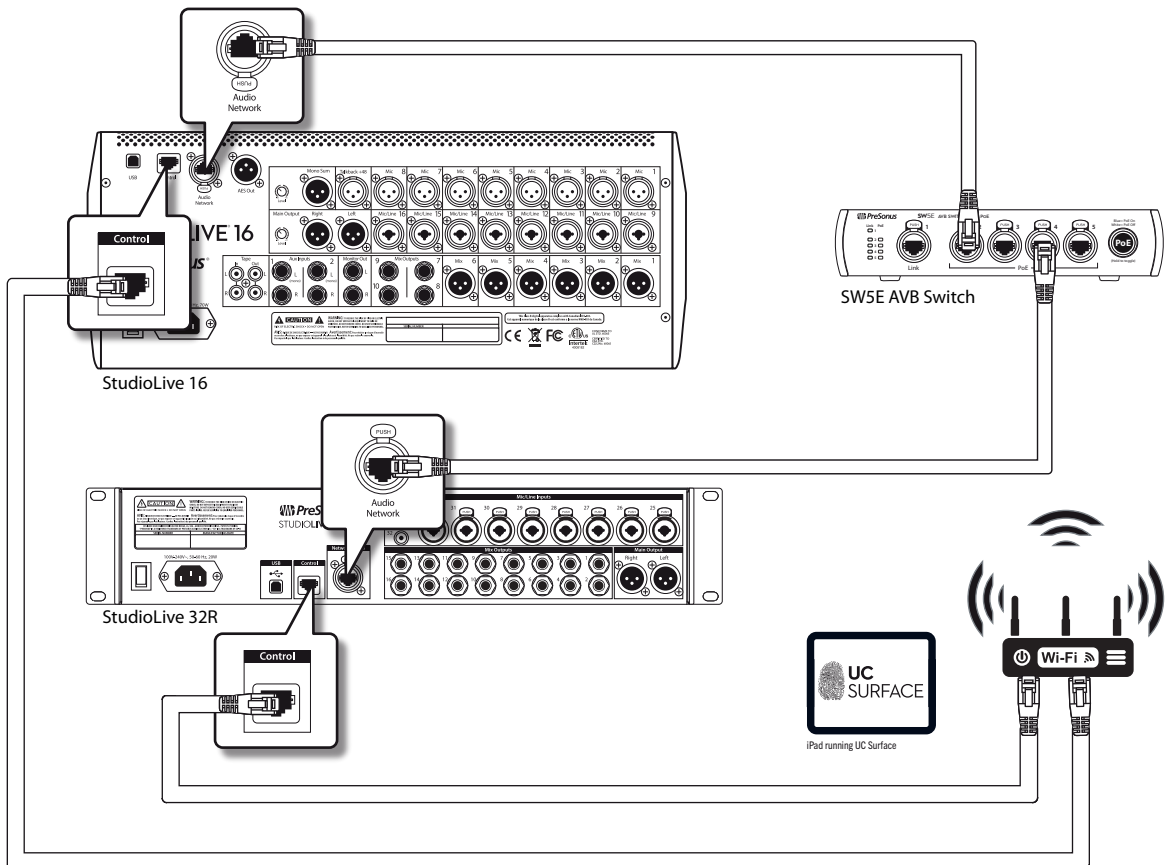

3.3 Choosing the Right Cables

AVB networks rely on a set of standards for cabling infrastructure to ensure that network performance is both reliable and consistent. These standards include specifications for the cable construction itself, as well as specifications for the termination of cabling and physical connections to devices.

Deviations from these specifications can result in reduced performance and even data loss, so it's important to use the right cable for the job, and to use good quality cable that meets the necessary specifications.

Cabling that is out of spec can result in dropped packets and intermittent connections. For simple data networks, such as those used to stream video or transfer files, it could just mean increased buffer times or transfer times. For live, real-time audio, it can mean audible dropouts in audio or loss of audio altogether.

3.3.1 Cat5e and Cat6

While AVB itself doesn't require gigabit Ethernet, PreSonus AVB product do require this speed because of the stream- and channel-counts involved. While this isn't a function of the cables themselves (the devices and AVB switches handle gigabit Ethernet), it is still an important consideration to keep in mind when building your AVB network because you must select Ethernet cable that is capable of supporting Gigabit speeds.

Copper-wire Ethernet networks generally use twisted-pair cable. Twisted pair cabling is a type of wiring in which two conductors of a single circuit are twisted together to cancel out electromagnetic interference (EMI) from external sources, and reducing crosstalk between neighboring pairs.

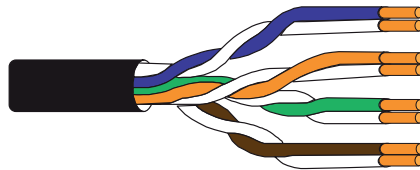

AVB networks require the use of either CAT5e or CAT6 cables, both of which support Gigabit speeds at lengths up to 100 meters, as specified by the TIA/EIA-568 standard. CAT6 is designed to support speeds up to 10 Gb/s (10GBASE-T or 10 Gigabit Ethernet), but it is backward compatible with CAT5e. The primary differences between CAT5e and CAT6 cable are the wire gauge of the conductors and the number of twists per inch in each wire pair. CAT6 cable uses heavier gauge wire and more twists per inch, providing lower crosstalk, higher signal-to-noise ratio, and an overall better performance rating than the CAT5e equivalent.

Which type of cable you choose for your application depends on several factors. Network design, installation type (fixed or mobile), budget, and future applications should all be considered when selecting the type of cable you will use. CAT5e cable is usually slightly more cost effective, may be easier to work with, and still fully supports Gigabit speeds, but Cat6 is generally a better choice and is well worth the additional investment given its capacity for faster speeds, especially when considering the future needs from your system.

Power User Tip: Always source your cable from a reputable vendor to ensure you are purchasing a high-quality product that meets the industry and engineering specifications it claims by its Category label (CAT5e or CAT6). Never purchase cables labeled CCA (Copper Clad Aluminum), as it does not meet the TIA/EIA specifications for Cat5e and Cat6 cabling.

3.3.2 Shielded vs. Unshielded

Foiled Unshielded Twisted Pair (UTP)

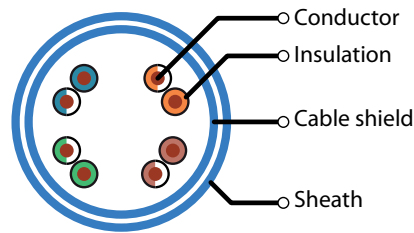

Unshielded Twisted Pair (UTP)

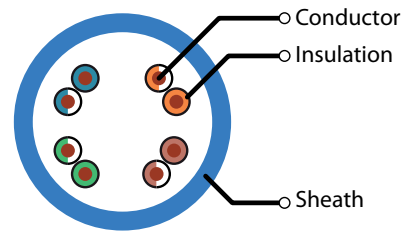

Shielded and Foiled Twisted Pair (STP)

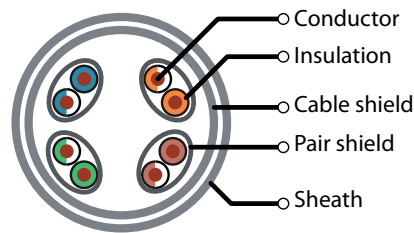

Shielded Twisted Pair (STP)

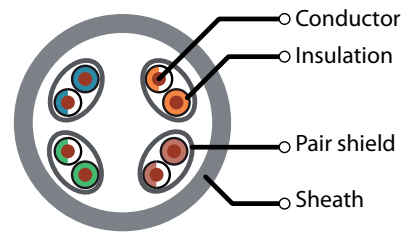

Whether you use CAT5e or CAT6 cable, you will have the option to use Shielded or Unshielded cable. Both cable types can be used for AVB networking and have advantages, depending on the type of AVB installation you are designing.

Shielded twisted-pair (STP) cables provide a barrier to help interference, especially electromagnetic interference (EMI). STP cable is constructed with additional electrical shielding along the length of the cable as well as specially constructed plugs that electrically connect and properly ground the cable shielding to the device connected at each end. Originally developed for industrial applications, shielded cable is ideal for fixed installations where Ethernet cable must be run near power, fluorescent lighting, etc.

Like a balanced analog cable, STP cables have to be grounded, so you'll need to use STP-compatible RJ45 connectors. Most XLR-style locking Ethernet connections you will find used on Pro Audio equipment, like the StudioLive Series III mixers and NSB stage boxes, are designed to be able to support both shielded and unshielded cable connections.

There are some specific use cases which might call for shielded Ethernet cable to prevent electromagnetic interference (EMI) or radio-frequency interference (RFI) from affecting the performance of the cable. It should be noted that if shielded cable is used but not implemented correctly, it can introduce problems and make things worse than using unshielded cable. As with everything in audio, if you are not experienced in installation or design, it's well worth the investment to consult a professional who is.

There are several different acronyms commonly used to describe shielded cables where the twisted pairs are not themselves individually shielded. These cable types rely on an overall shield or screen to filter out external noise. While you may find them used synonymously, there are important differences to note:

- **SF/UTP.** This cable features a braided screen (S) and a foil shield (F) that surrounds unshielded twisted pairs (UTP). Cables with an overall braided screen are great for applications that need extra protection from EMI.
- **S/UTP.** This cable features a braided screen (S) surrounding unshielded twisted pairs (UTP).
- **F/UTP (FTP).** This cable uses an overall foil shield (F) to protect the unshielded twisted pairs (UTP) and is essentially very similar to a simple UTP cable, offering very little protection.

- **S/FTP.** This cable features an overall braided screen (S) encasing foil-screened twisted pairs (FTP). In this design, each twisted pair is protected by its own foil screen to limit the amount of crosstalk between them.
- **F/FTP.** In this design, an overall foil screen (F) protects individually wrapped foil-screen twisted pairs (FTP).
- **U/FTP.** This design removes the overall screen and relies only on the individual foil-wrapped twisted pairs (FTP) to limit interference.

Unshielded twisted pair (UTP) and its cousins, U/FTP and F/UTP are lighter weight and more flexible. These cable types have the benefit of being easier to terminate and much more flexible than their shielded counterparts. What type of cable you select depends largely on your application and the amount of environmental interference you anticipate encountering.

3.3.3 Solid-core vs. Stranded

Another thing to keep in mind when selecting Ethernet cable is whether it is solid- or stranded-core. In a solid-core cable, each of the conductors is a single copper wire, which is a better fit for installations and long cable runs (more than 70m). Stranded-core cables use multiple, thinner copper wires for each conductor, making them more flexible and easier to handle. This makes stranded-core cable a better fit for touring and shorter cable runs.

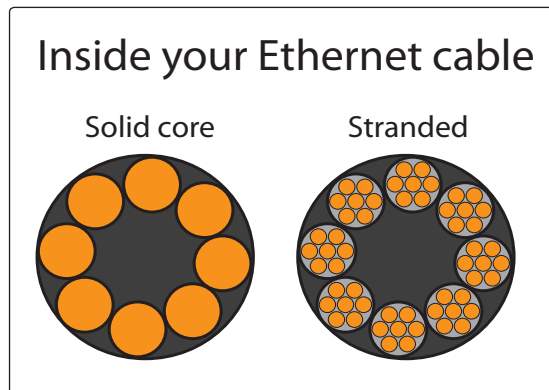

Most Ethernet cable is solid-core, constructed using solid insulated bare copper conductors for each of the eight wires in the four twisted pairs of the cable. These cables are meant to be used in permanent and semi-permanent installations, and are designed for longer distance horizontal and backbone cable runs. All CAT5e and CAT6 solid UTP cables are designated with a minimum bend radius for performance standards. The bend radius is the minimum radius a cable can be bent without kinking it, which can lead to damage and shorten its life. The minimum bend radius for Category 5, 5e, and 6 cable is four times the cable diameter, or about one inch. Proper cable installation is essential in order to maximize the performance of the cable.

In the case of a mobile live sound operation, with frequent setup and teardown, solid-core Ethernet cable probably isn't the best choice, as it's generally stiffer and not conducive to easy layout and flat deployment runs. Solid-core cables should not be over-flexed, bent, or twisted beyond the cable's recommended specifications, as you risk damaging the cable, causing it to underperform or even fail.

Stranded Ethernet cables have multiple strands (typically 7 strands per conductor) of insulated bare copper conductors. These cables are typically used for patch cords/cables connecting devices to the network, but because these cables are more flexible than solid conductors, they are an excellent choice for portable uses and applications where repeated flexing is common, such as frequent setup and teardown of a live sound PA system.

A Quick Note About Tactical Ethernet Cable

When you need Ethernet cable that is intended specifically for harsh environments with repeated deployment, a special type of cable should be considered. Tactical cable generally uses stranded-wire construction for flexibility and durability, as well as employing a heavy, often rubberized outer jacket in addition to the lightweight PVC jacket (sometimes referred to as "up-jacketed"). Tactical Ethernet cable has a very similar feel and handling characteristics to balanced audio cable, and is much more rugged than common solid-core cable used for in-wall building installation, making it ideal for Pro Audio and Live Sound applications.

3.3.4 Plug Termination

Making your own Ethernet cables can be a great way to save money, and allows you to create cables to fit your needs and specifications exactly. If you choose to make your own Ethernet cables, it's important to be aware of some possible pitfalls and follow some important general guidelines.

Most RJ-45 connectors are designed to be used with either solid-core or stranded cable; however, you should always confirm the connector's compatibility to the type of cable you are deploying. Using a plug designed for one type of cable with the wrong cable type can produce unreliable results.

The same is true for CAT5e and CAT6 cable connectors. Most RJ-45 connections are only meant to be used specifically with one or the other. Additionally, some connectors are designed for specific wire gauges and cable diameters, so, again, you should always confirm your connector's compatibility with the specific cable you are using.

***Power User Tip:** Just like sourcing cable, it's important to source quality connector from a reputable vendor. The connector itself is one of the most crucial pieces in the equation. Even the highest quality cable is only as good as the connections terminating each end.*

3.3.5 T568A or T568B

There are two wiring pinouts defined by TIA/EIA standards: T568A and T568B. Currently, T568B is used almost universally in the U.S. - a legacy of analog telephone compatibility - while T568A is more common worldwide. Either is perfectly acceptable as long as you are consistent. If you're doing a new wiring install, it's best to choose one or the other and stick with it throughout your network. If you're making new cabling and not sure about an existing wiring install, don't worry, it's even okay to intermingle the two standards for the most part. The most important consideration and the only rule you absolutely must follow is that for a given cable or run, **you must use the same wiring standard on both ends.**

3.3.6 Twisted Pair Tips

When building your own twisted-pair Ethernet cable, it is crucial that the twists are maintained as close as possible to the contact termination within the plug as possible. You'll also want to make sure that the wire pairs running to adjacent pins are parallel inside the plug body all the way to the pin. You don't want different pairs wrapped around each other or have wires bunched up inside the plug and pressed against each other.

Trimming the wire pairs to the proper length is also crucial, as you want to make sure that the back-crimp of the plug is clamping down on the cable jacket, not the wires themselves.

You might be surprised at how easy it is to create a poor termination and how narrow the window is between a working cable and a failing cable. The crosstalk performance and EMI rejection capabilities of Ethernet cable, which ensure it will function up to its rated specification, are entirely dependent on maintaining these relationships of the wires within the cable and the plug termination. A little attention to detail goes a long way in this respect. Again, if you are unfamiliar with proper termination techniques, PreSonus recommends consulting with a professional.

3.4 Understanding Hops

In its simplest terms, 1 LAN is equal to 1 hop, where the LAN is the span between two AVB switches (also known as 'bridges'). Take a look at the examples below. These examples are fairly straightforward: one LAN connection equals one AVB hop.

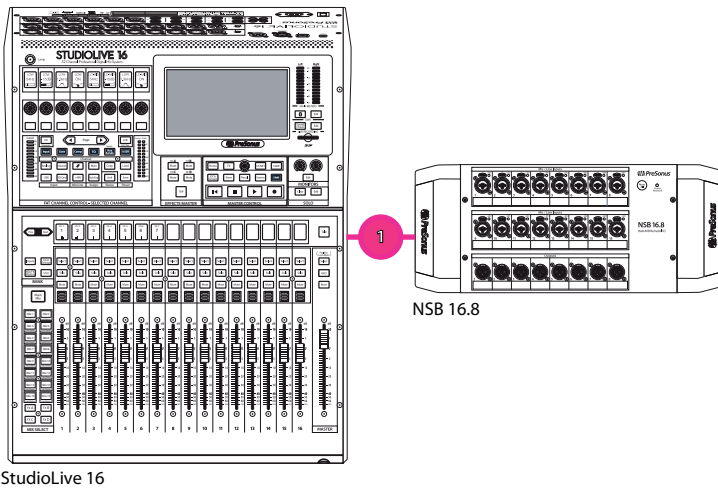

In this next example, the EarMix 16M has a third hop because the input channels from the NSB16.8 stage box are being routed to the StudioLive 16, where they are processed by the Fat Channel and added to FlexMixes before they are then sent back out to the network and on to the EarMix 16M, making three total hops between the NSB 16.8 and the EarMix 16M.

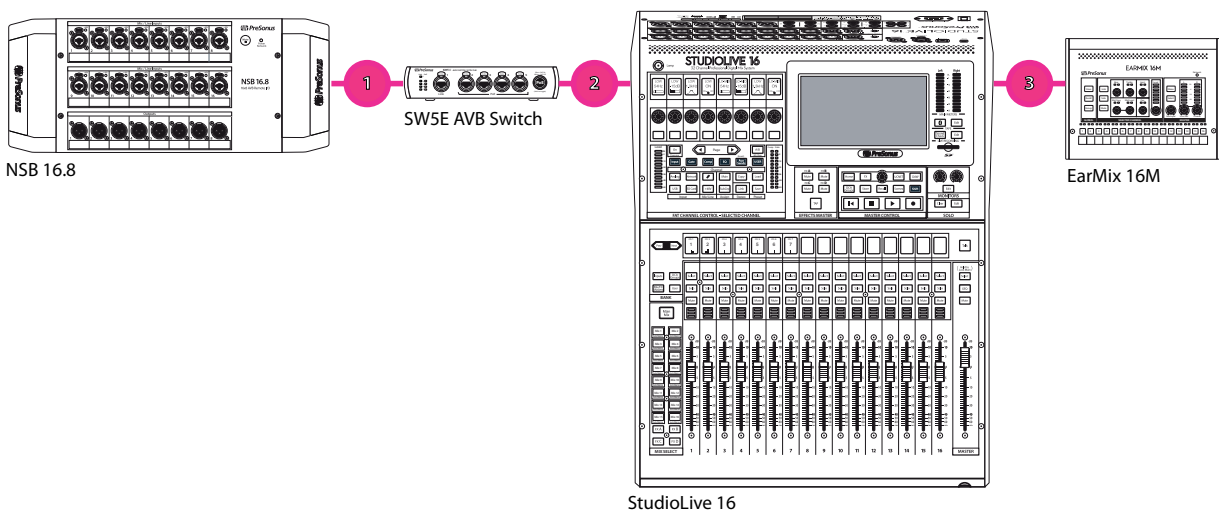

The more switches or devices that are cascaded, the more potential for additional hops being added between devices on your network. As hops are added, the potential for the latency between the source and destination to exceed the limits set by the AVB specification is increased. Because of this, PreSonus recommends a maximum of six hops between source and destination.

3.5 Network Topologies

AVB provides several different methods of Network topology. This section will outline the three different methods of connecting your PreSonus AVB network. It is important to note that these three different topologies can be used individually or combined depending on your particular application.

When deciding which method or methods will best suit your needs, take into consideration your channel count, system latency, the number of locations, as well as future needs to expand your system.

3.5.1 Point-to-Point (P2P)

A point-to-point or P2P network is the simplest to design. While not technically a network in and of itself, a Point-to-Point configuration relies on networking protocols in order for two devices to transmit data to one another.

The most common example of this type of topology is a digital mixer, like a StudioLive Series III console mixer, connected to a network stage box, such as an NSB 8.8 or NSB 16.8:

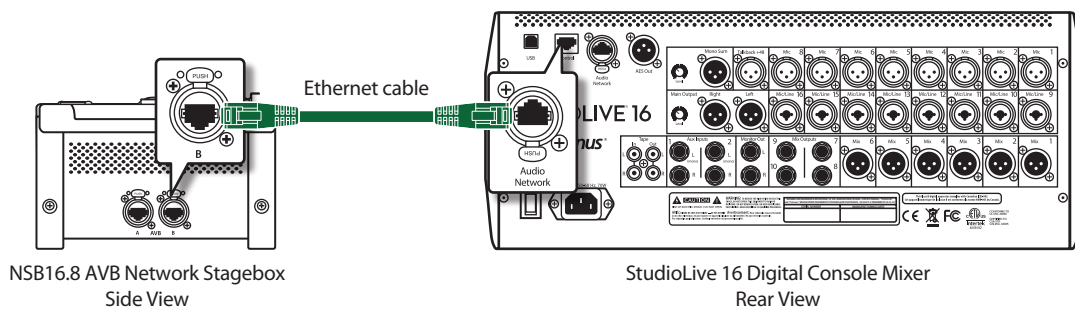

Another example is created when using a StudioLive Series III console mixer at Front-of-House and a StudioLive Series III rack mixer in Monitor mode:

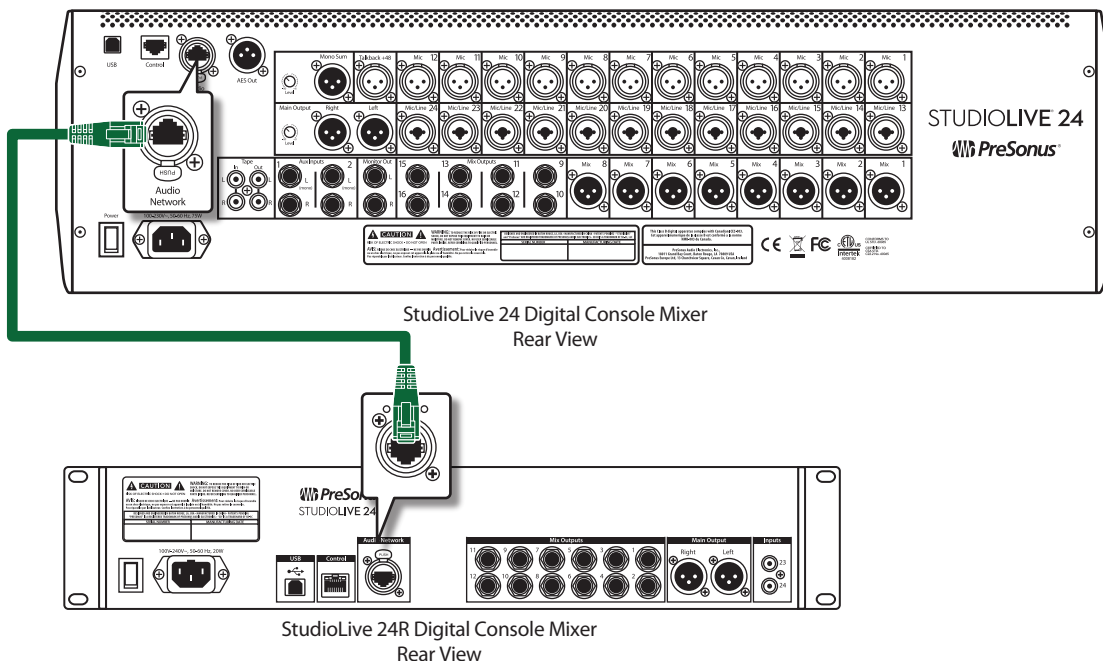

In both of these examples, an Ethernet cable is run from one device to the other and the routing is handled efficiently from the console mixer's touchscreen.

3.5.2 Daisy-Chain

A daisy-chain topology allows you to connect devices serially. This configuration requires a device have a built-in AVB switch that provides an additional port, like the PreSonus NSB-series stage boxes and EarMix 16M personal monitor mixers. Because of this, when connecting a simple network, you can connect your devices as follows:

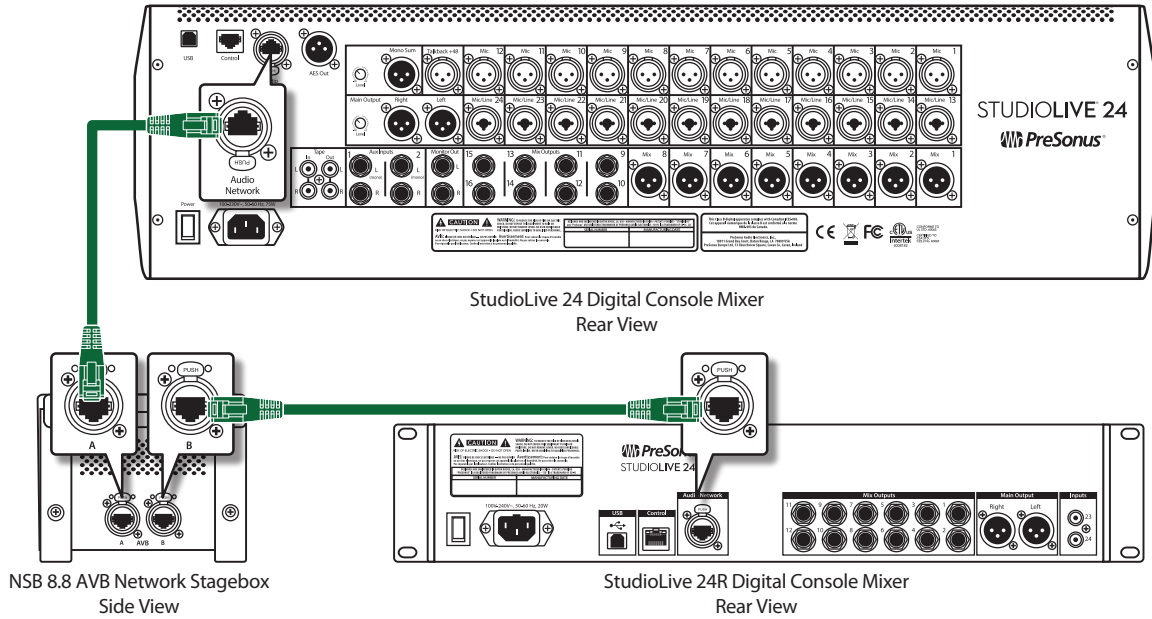

3.5.3 Star

It is important to mention that the Daisy-chain topology creates the potential for additional and unnecessary hops that could be omitted when using a centralized AVB Switch. This is where the Star topology becomes ideal for networks that require the use of more than just a handful of devices.

A star topology utilizes the network’s bandwidth more efficiently. It also minimizes hops and the additional latency that can come with it. Star networks are based around a centrally located switch or switches. All the nodes on the network are connected to this switch, so there are fewer hops between devices.

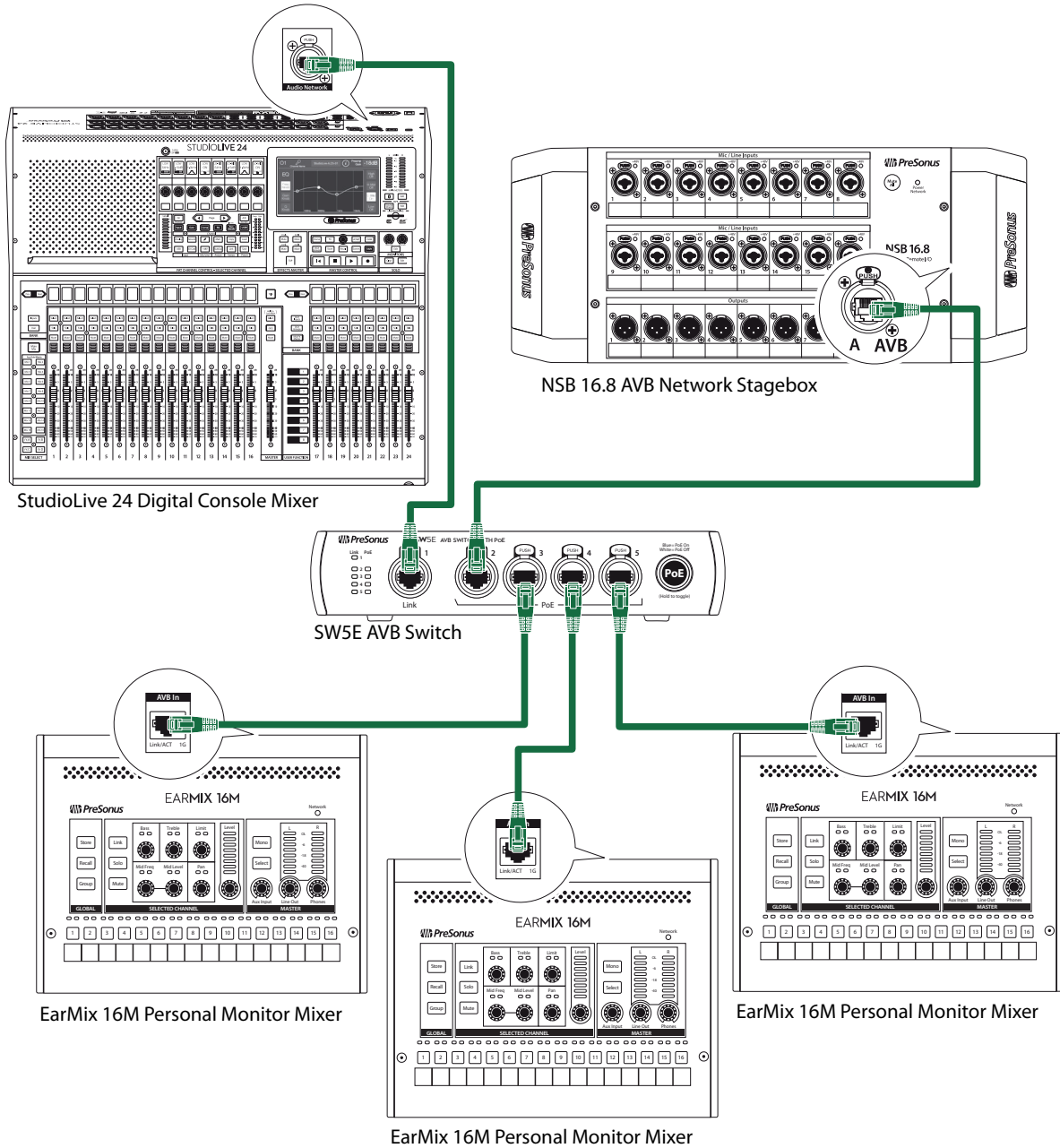

Star topologies are easily expanded, making them a great solution for dynamic applications. For devices that support PoE (Power over Ethernet), like the EarMix 16M, a star topology provides the added benefit of delivering audio and data connectivity as well as power, when using a PoE switch, like the SW5E.

4 Configuring Your AVB Network

4.1 Using AVB with a StudioLive Series III Mixer and a Mac

StudioLive Series III mixers allow you to record and playback audio over AVB on any Mac that supports AVB. A single computer can be used both to control and to record from the StudioLive, or separate computers can be used for control and audio.

Note: At the time of publication Apple only supports connecting one computer via AVB. Once a StudioLive Series III mixer has been selected as an AVB audio device for an Apple computer, no audio can be routed to or from that mixer without using Apple's AVDECC controller. Because of this, PreSonus recommends using USB for recording on small AVB networks containing only PreSonus devices.

4.1.1 What You Will Need

- StudioLive Series III mixer
- An AVB-compatible Mac running 10.9.5 or later. Any Mac with a Thunderbolt connection should provide hardware support for AVB.
- If your computer does not have a built-in Ethernet port, you will also need a Thunderbolt-to-Ethernet adapter. USB-to-Ethernet adapters do not support AVB.

Note: Recording over AVB is not supported while using Stagebox mode with your StudioLive Series III mixer. Connecting a Mac to your AVB network with your StudioLive mixer enabled as an AVB device will disable Stagebox mode.

4.1.2 Making the Connections

If you would like to remote control the mixer using UC Surface or QMix-UC, the control port on the back of the mixer must be connected either directly to a control device or to the same wireless network as the device running the control software. The easiest configuration is to connect a wireless router to the mixer's control port and then connect your computer or other remote devices to the router using either wired or wireless connections. If you need AVB audio between more than just the mixer and the one computer, you can incorporate an AVB switch to create a full AVB network.

Note: StudioLive Series III mixers cannot be remotely controlled over the audio network connection.

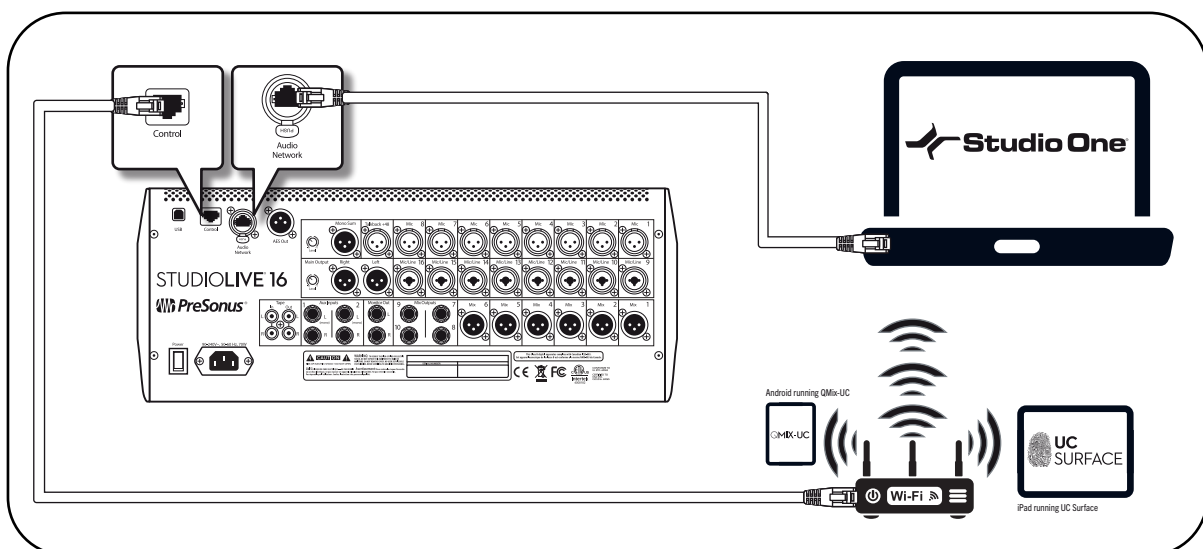

4.1.3 Setting Up Your Mac

When a StudioLive mixer is configured as an AVB audio interface for your Mac using Core Audio, MacOS will acquire the AVB device, and prevent any other AVB device from sending or receiving streams to or from the mixer. Because of this, PreSonus recommends using the USB connection for recording and playback when a StudioLive mixer is used as a part of a PreSonus AVB ecosystem network.

If your Mac doesn't have an Ethernet port, you can connect your mixer via Ethernet using a Thunderbolt-to-Ethernet adapter. USB-to-Ethernet adapters cannot be used because the USB chipset used in Mac computers does not support AVB Ethernet.

1. Open Audio/MIDI Setup.



2. Go to Window>Show Network Devices Browser.

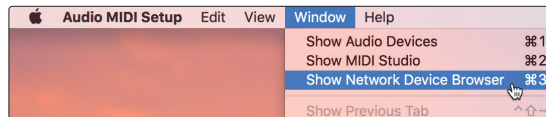

3. Check the box next to your mixer to enable it as a Core Audio device over AVB (this may take a moment)

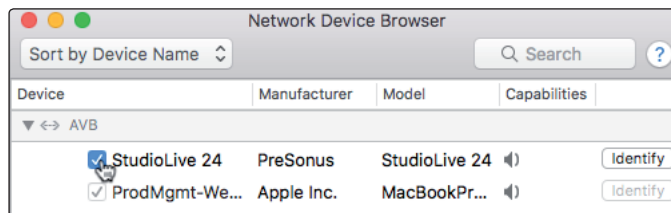

Once your computer has successfully connected to your StudioLive Series III mixer, your mixer will appear in Audio MIDI Setup as an available audio device that you can use with any software that supports Core Audio (Studio One, Pro Tools, Logic, etc.).

4.2 NSB-series Stage Box with a StudioLive Series III Console Mixer

NSB-series stage boxes can be configured from the touchscreen on any StudioLive Series III console mixer. It should be noted, however, that UC Surface configuration is also available. Please review **Section 4.3** for instructions.

4.2.1 Step 1: Connect Your Stage Box to Your Mixer

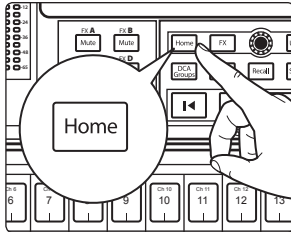

1. Press the Home button on your StudioLive Series III mixer.

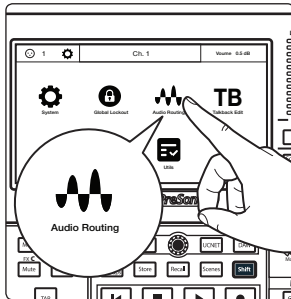

2. Press the Audio Routing icon on the Touchscreen.

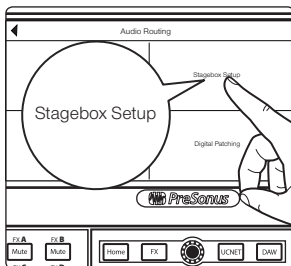

3. Press the Stagebox Setup button on the Touchscreen.

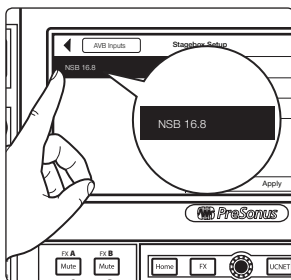

4. Select the NSB-series stage box from the list on the left.

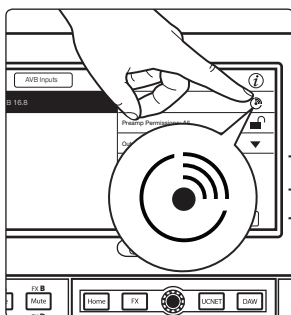

Power User Tip: In applications where you are using multiple NSB-series stage boxes of the same model, you can press the Identify button. This will flash the Power Network LED on the front of the selected NSB stage box from green to red, allowing you to quickly locate your selection.

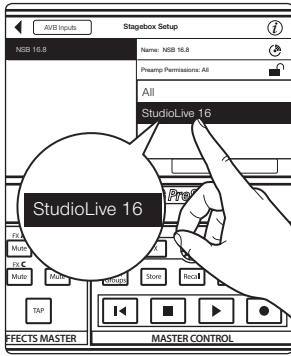

5. Select the mixer you'd like to use to control the preamps on your NSB stage box. By default, this is set to "All," enabling any StudioLive Series III mixer on the AVB network to control the preamps on your stage box.

Power User Tip: Because your NSB stage box inputs are most likely routed to multiple sources on your network, PreSonus highly recommends designating one mixer to control the NSB preamps. Please review your NSB-series Owners Manual for information on preamp permissions and gain compensation.

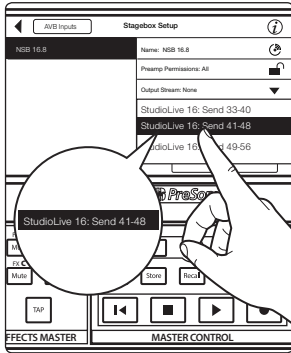

6. Select the AVB Output Sends you'd like returned to the physical outputs on your NSB stage box. Because the AVB streams are routed in banks of 8, you can only source these outputs from one mixer on the network.

Note: As previously mentioned, this is also the clocksource for your NSB-series stage box. You must assign an output stream from your mixer to your NSB-series stage box so that it is clocked properly over the network. If you do not assign an output stream from your mixer, your networked stage box will not be properly synced and you will hear audio artifacts.

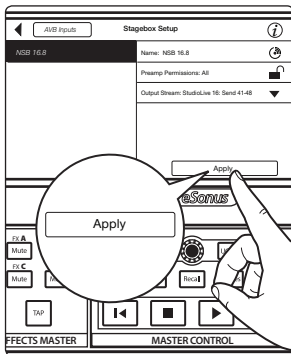

7. Press the Apply button when finished.

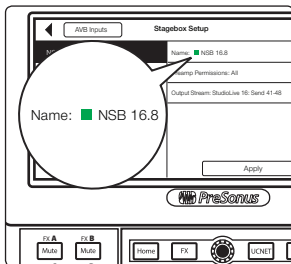

Power User Tip: Once send streams from your mixer have been successfully patched, you will see a green status indicator next to your NSB stage box in the setup screen.

4.2.2. Step 2: Routing Stage Box Inputs to Mixer

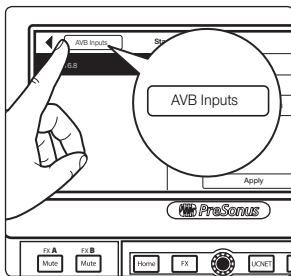

1. Press the AVB Inputs button.

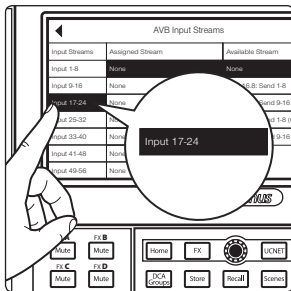

2. Select the desired mixer input stream from the Input Streams list.

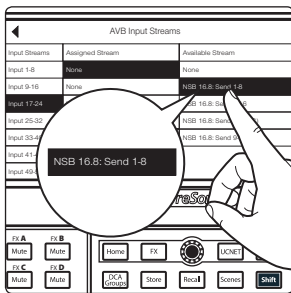

3. Select the desired NSB AVB output stream from the Available Stream list to patch the NSB inputs to selected channels on your mixer.

Note: NSB stage boxes have two sets of streams: one with Gain Compensation and one without. Please review your NSB-series Owners Manual for more information on Gain Compensation and when it is advantageous or even required.

4.2.3 Step 3: Engage Network Sources

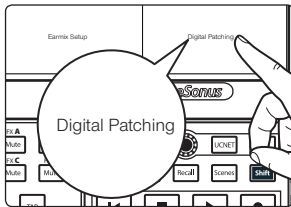

1. Press Digital Patching from the Audio Routing menu.

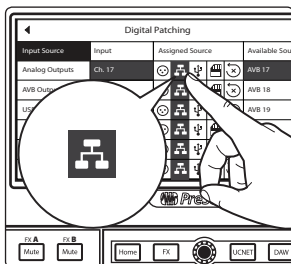

2. Select Input Source and assign the Network source for the desired channels by pressing the Network button next to each Input.

OR

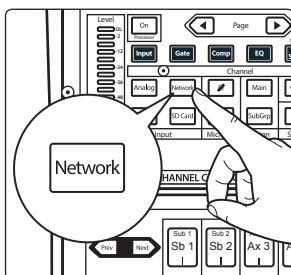

Select each channel and press the Network button from the Input source section in the Fat Channel.

Your NSB-series stage box is now ready to use!

4.3 NSB-series Stage Box UC Surface Setup

As previously mentioned, NSB-series stage boxes can be configured and routed from the touchscreen on the StudioLive Series III console mixers. This can also be done from UC Surface for all StudioLive Series III mixers.

4.3.1 Step 1: Connect Your Stage Box to Your Mixer

1. Launch UC Surface and connect to your StudioLive Series III mixer.



2. Click or Tap on the Settings Gear.

3. Click or Tap on the Network tab.

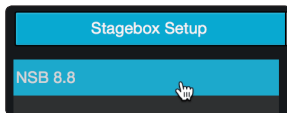
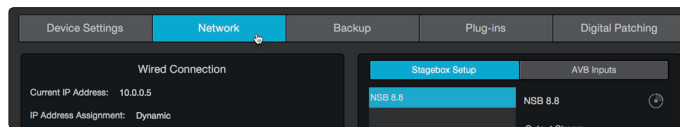

4. In the Stagebox Setup area, select the NSB-series stage box from the list.



Power User Tip: In applications where you are using multiple NSB-series stage boxes of the same model, you can press the Identify button. This will flash the Power Network LED on the front of the selected NSB stage box from green to red, allowing you to quickly locate your selection.

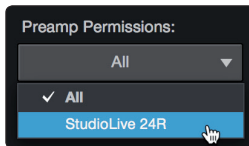

5. Select the mixer you'd like to use to control the preamps on your NSB stage box. By default, this is set to "All," enabling any StudioLive Series III mixer on the AVB network to control the preamps on your stage box.

Power User Tip: Because your NSB stage box inputs are most likely routed to multiple sources on your network, PreSonus highly recommends designating one mixer to control the NSB preamps. **For more information on preamp permissions and gain compensation, please review the NSB-series Owners Manual.**

6. Select the AVB Output Sends from the mixer that you'd like returned to the physical outputs on your NSB stage box. Because the AVB streams are routed in banks of 8, you can only source these outputs from one mixer on the network.

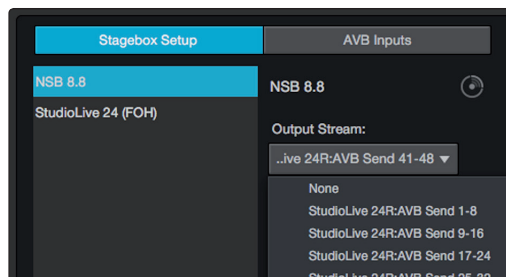

Note: As previously mentioned, this is also the clocksource for your NSB-series stage box. You must assign an output stream from your mixer to your NSB-series stage box so that it is clocked properly over the network. If you do not assign an output stream from your mixer, your networked stage box will not be properly synced and you will hear audio artifacts.

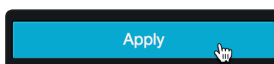

7. Press the Apply button when finished.

4.3.2 Step 2: Routing Stage Box Inputs to Your Mixer

1. Click on the AVB Inputs tab.



2. Next to desired inputs on your mixer, select the NSB AVB Send stream you would like to use from the Available Stream drop-down menu. This will patch the selected inputs on your NSB stage box to these channels on your mixer.

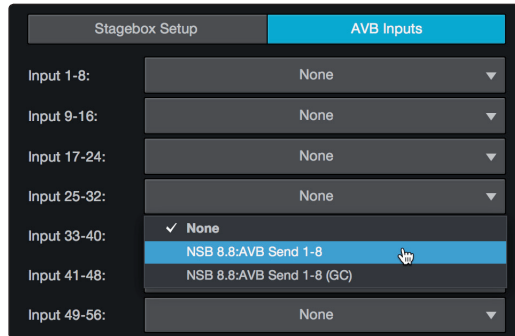

Note: NSB stage boxes have two sets of streams: one with Gain Compensation and one without. Please review your NSB-series Owners Manual for more information on Gain Compensation and when it is advantageous or even required.

4.3.3 Step 3: Engage Network Sources

1. Click or tap on the Digital Patching tab.

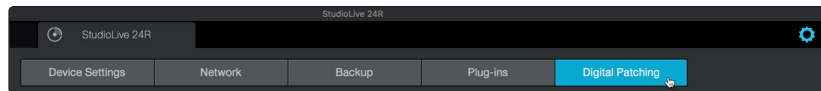

2. By default, the Input Source tab will be active. Select AVB from the Source Type selection.

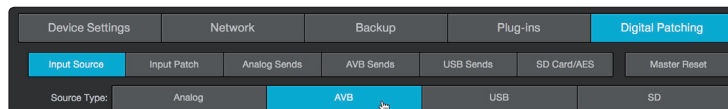

3. Click or tap on the source icon for channels on your StudioLive mixer to change each channel's source input to AVB. This will enable the corresponding NSB stage box input to each channel. In the example below, NSB Input 1 will be enabled on StudioLive 24R channel 25, NSB Input 2 will be enabled on StudioLive 24R channel 26, etc.

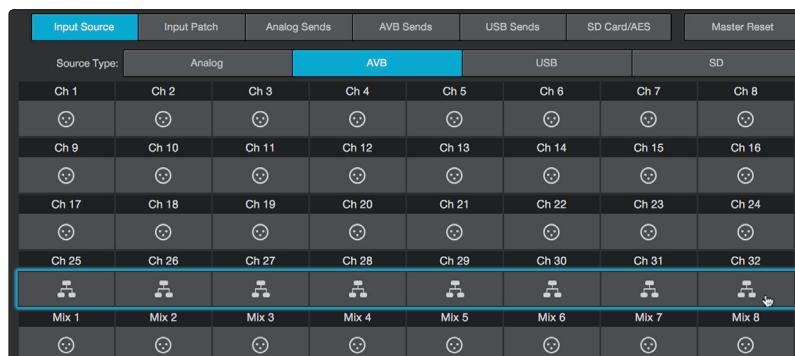

Your NSB stage box is now ready to use!

4.4 EarMix 16M with StudioLive Console Mixers

EarMix 16M personal monitor mixers can be configured from the touchscreen on any StudioLive Series III console mixer. It should be noted, however, that UC Surface configuration is also available. Please review **Section 4.5** for instructions.

1. Press the Home button on your StudioLive Series III mixer.

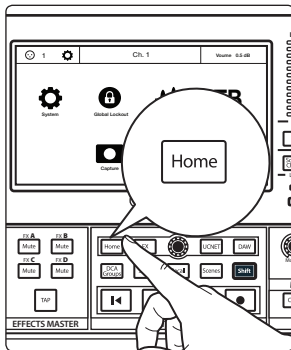

2. Press the Audio Routing icon on the Touchscreen.

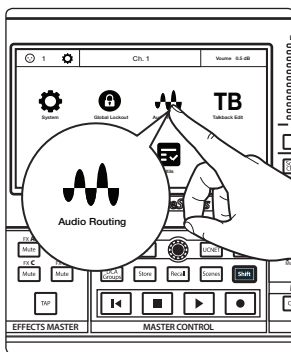

3. Press the EarMix Setup button on the Touchscreen.



4. Select EarMix 16M from the list on the left.

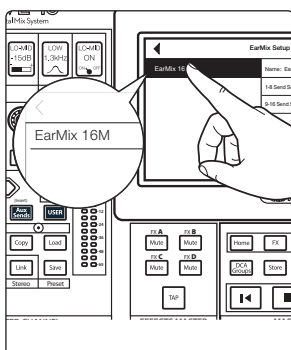

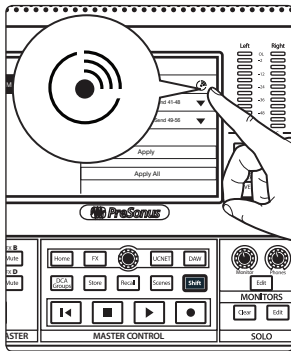

If you are unsure which EarMix 16M is which, press the Identify button. This will flash all the Select buttons on the currently selected EarMix 16M.

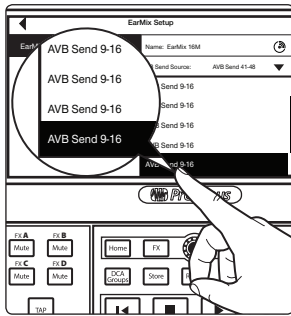

5. Next, you will need to select the AVB Sends from your mixer to which you route to your EarMix. By default, the last 16 AVB Inputs are patched from Flex Mixes 1-16.

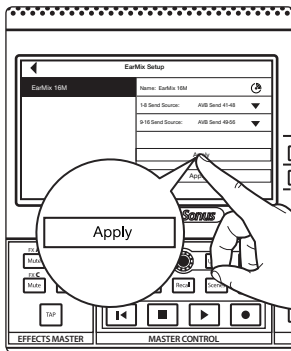

6. Press apply to finish.

Power User Tip: If you are configuring multiple EarMix 16M Personal Monitor Mixers and would like them to receive the same routing from the mixer, press the Apply All button. This will apply the current AVB routings to every EarMix 16M currently on the AVB network.

4.5 EarMix 16M Setup from UC Surface

As previously mentioned, EarMix 16M personal monitor mixers can be configured and routed from the touchscreen on the StudioLive Series III console mixers. This can also be done from UC Surface for all StudioLive Series III mixers.



1. Launch Universal Control.

2. Select your mixer from the device list.



3. Click or Tap on the Settings Gear.



4. Click or Tap on the Networking tab.

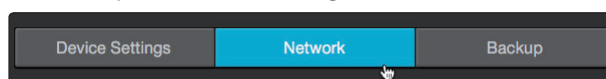

5. Select EarMix 16M in the device list.

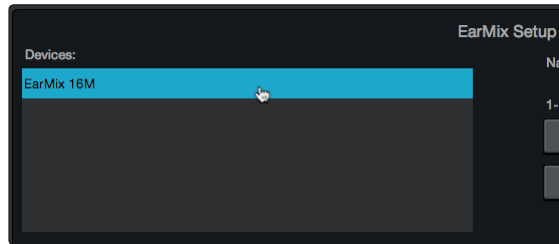

If you are unsure which EarMix 16M is which, click or tap the Identify button. This will flash the Select buttons on the currently selected EarMix 16M.

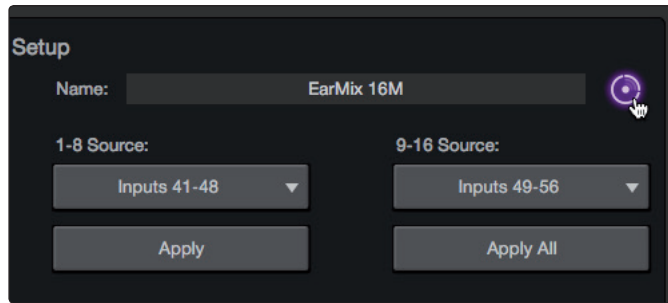

6. Select the desired StudioLive mixer AVB sends for Source Selection 1-8 and 9-16.

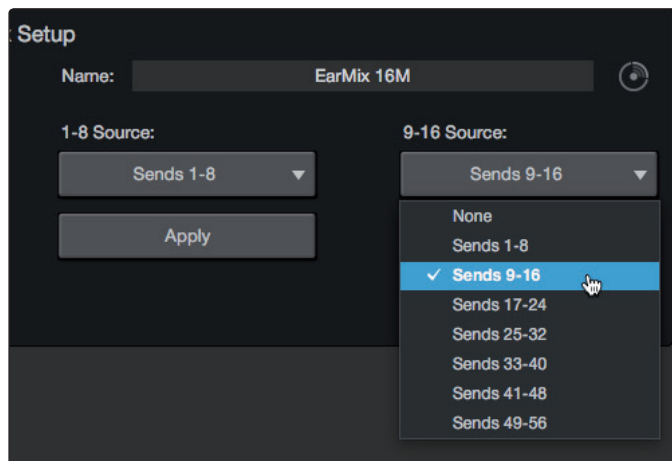

7. Press apply to finish.

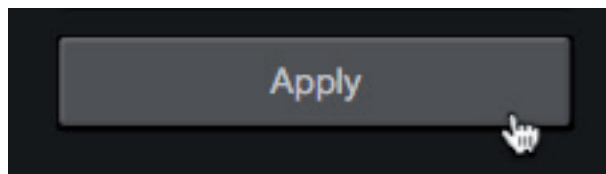

5 Large Network: Real-world Example

This section provides detailed instructions on creating a large network that combines all of the information covered in this guide. These instructions can be altered and applied to other installations as necessary and are meant to serve as an example configuration.

This guide will break down the example system as follows:

- AVB and Control Network Connections
- Audio Input Connections
- Audio Output Connections

5.1 Example Network Overview

Our example will consist of the following PreSonus products. It should be noted that any PreSonus StudioLive Series III mixer can be used for any or all of the applications described below. The exception being the StudioLive 16R. While the set-up instructions are the same, this mixer is not expandable to 32 inputs, 16 Flex Mixes, and 4 subgroups like the rest of the family:

Front-of-House Console

A StudioLive 24 console mixer is used for Front-of-House. This compact console is a full 32-channel mixer with 16 Flex Mixes and 4 Subgroups that can be routed to and from the network. While the onboard analog I/O is limited, this mixer can be expanded using any StudioLive Series III mixer, NSB-series stage box, or EarMix 16M personal monitor mixer.

The StudioLive 24 at Front-of-House in our example will receive its channel sources as follows:

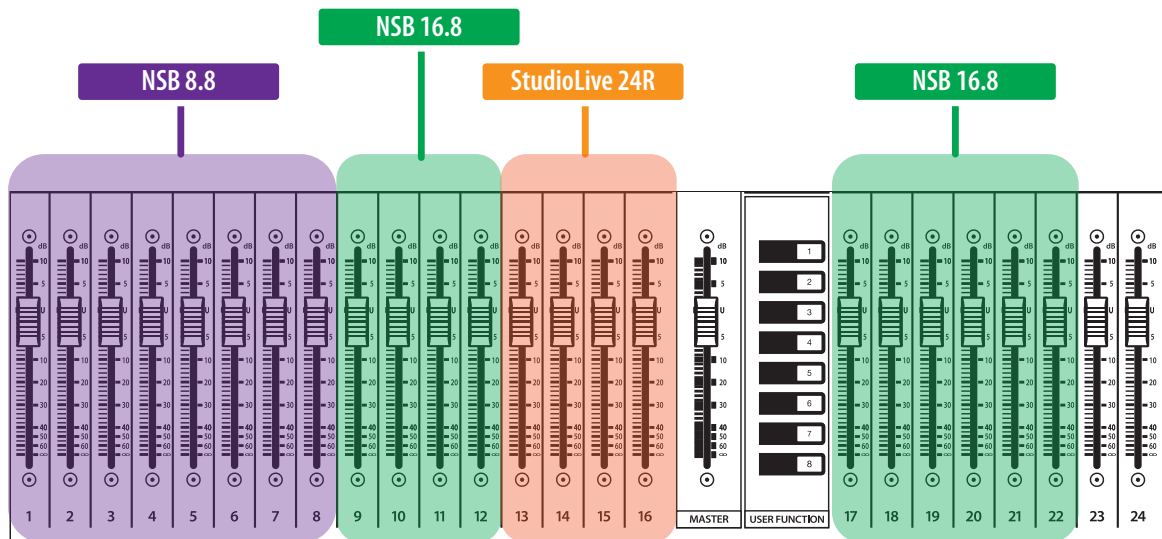

Broadcast Console

A second StudioLive 24 is shown in a remote broadcast location on the network. Because this is an independent stand-alone mixer, it can source its input and output streams locally or from anywhere on the network and then mix them down for a live stream on a computer connected via USB, or use any of the analog mix outputs or the AES output to feed an external broadcast system.

The StudioLive 24 at Broadcast e in our example will receive its channel sources as follows:

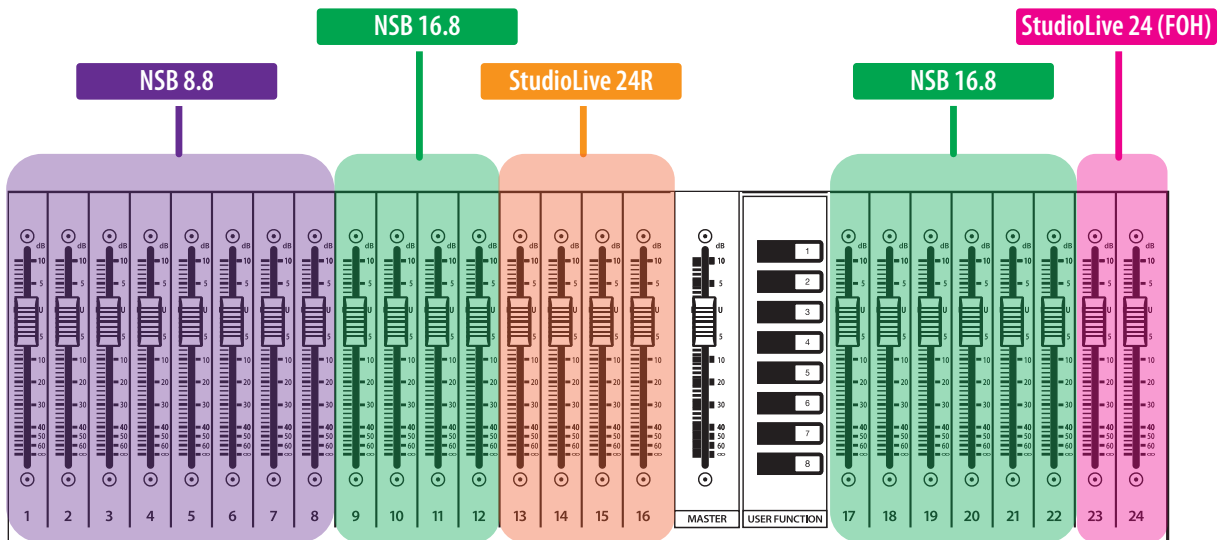

Monitor Mixer

A StudioLive 24R will be used in Monitor Mix mode allowing us to easily mirror the main mix while retaining the ability to create monitor mixes for the local Flex Mixes to feed floor wedges. Because the StudioLive 24R is controlled exclusively by UC Surface, the monitor mixes can be controlled anywhere in the venue, even from stage or Front-of-House, if necessary. *For more information on UC Surface, please review the QMix-UC Reference Manual.*

The StudioLive 24R at Monitor position in our example will receive its channel sources as follows:

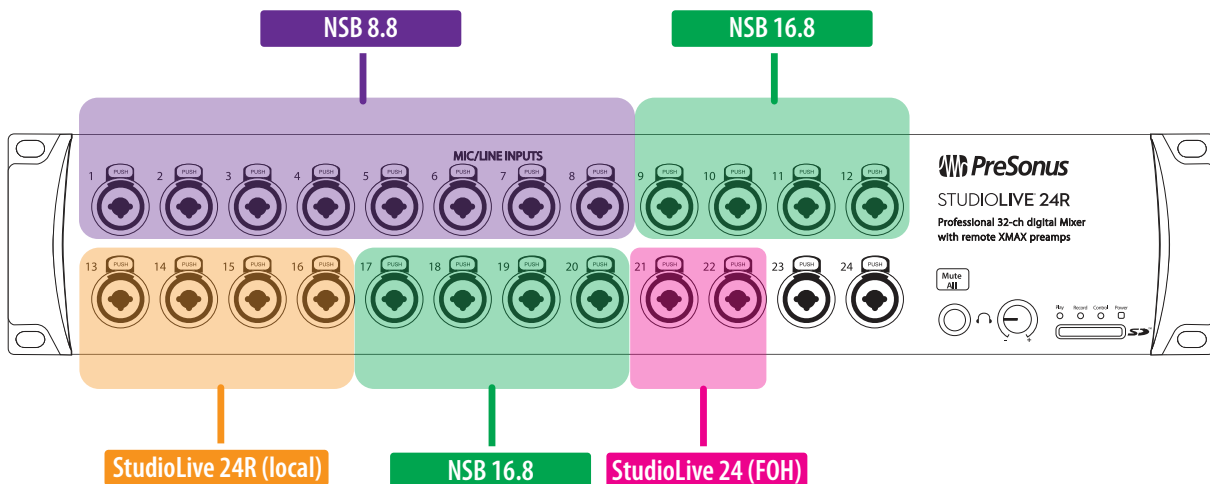

Personal Monitoring

Personal monitoring will be available both from four EarMix 16M personal monitor mixers as well as from QMix-UC. Each EarMix 16M is a 16-channel digital mixer that receives audio inputs exclusively over AVB to be mixed locally from the EarMix control surface. EarMix 16M personal mixers are equipped with a high-voltage headphone amplifier and stereo line outputs to feed either headphones or powered floor wedges.

By contrast, QMix-UC is an Android™ and iOS® app that remotely controls the Aux Mixes on a StudioLive mixer. This is a great solution for musicians using wireless in-ear system who desire simple, handheld control on their personal mobile device. **For more information on QMix UC, please review the QMix-UC Reference Manual.**

Each of the four EarMix 16M personal monitor mixers in our example will receive their channel sources as follows:

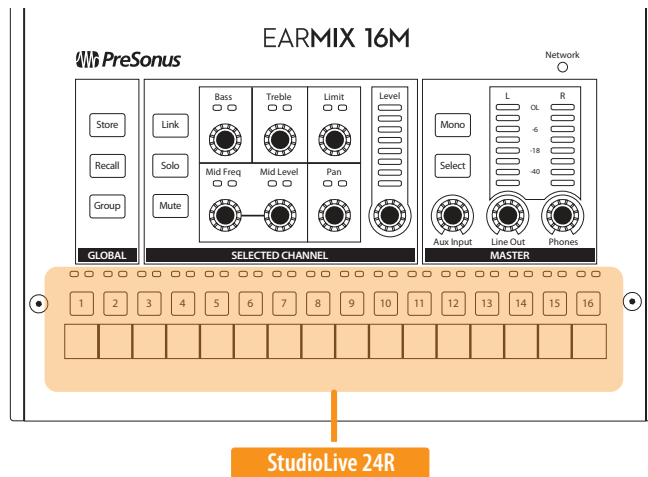

Stage Boxes

An NSB 8.8 and NSB 16.8 will both be added to the network to provide two different locations on stage for analog connections to simplify cable runs. The NSB 8.8 will be used exclusively for the drum kit. The NSB 16.8 will provide input connections for the rest of the band.

In addition to providing analog input connections on stage, the outputs of the two NSB-series stage boxes will receive their sources in our example as follows:

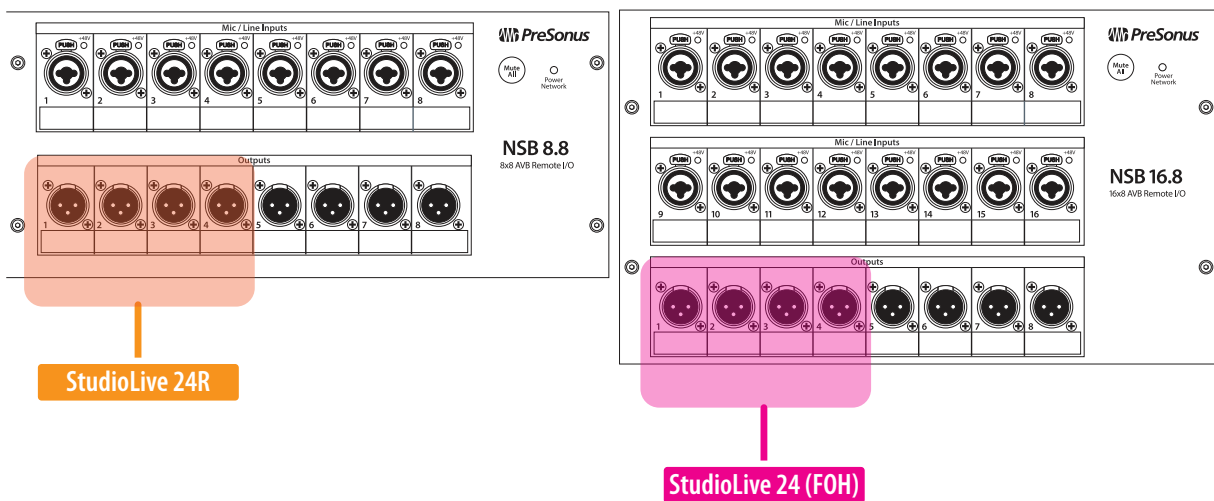

Network Switches

Two PreSonus SW5E AVB network switches will be added to the network. One switch will be used exclusively for the EarMix 16 Personal Monitor mixers so that all four devices can be powered over Ethernet. This system also utilized the network switch built into the NSB-series stage boxes to facilitate greater connectivity with fewer components.

Recording System

A computer is connected over USB to the StudioLive 24 at Broadcast position to record up to 40 sources. StudioLive Series III mixers include both Capture and Studio One Artist.

Wireless Router

A wireless router will be added to provide a LAN control network for devices running UC Surface and QMix-UC. Please visit www.presonus.com for a list of recommended wireless routers. Configuration tutorials are available at www.presonus.com/learn/technical-articles.

5.2 Network Connections

Before beginning any Network configuration, it is highly recommended that you follow the following best practices:

- **Draw it.** Just like when you create a complex analog audio system, when you begin creating an AVB network, we recommend creating a diagram on paper, before you start connecting equipment. Not only will this provide you with a map from which to work more efficiently, it will also save you hours of cable tracing later should something go wrong, because you'll know where all the Ethernet cables are going.
- **Label it.** Sure you think you'll remember that your Front-of-House console is connected to AVB port 2 on your switch and port 5 of your LAN router, but best to be safe and label the cables at both ends, just to be sure.
- **Place it.** Place your gear where it needs to be located before you connect any cables, especially if you're making your own. This will save time when you're running cables later because you know you'll be running them to the correct location.
- **Stretch it.** Always leave a little slack in your cable runs. Ethernet cable is not like analog cable in that it is not subject to the signal degradation that comes from long cable runs. This will provide you with some flexibility and room to adjust in the future.

In the diagram that follows, each component is connected to the AVB network utilizing a modified star topology with the NSB-series stage boxes and StudioLive 24R attached using a daisy-chain topology. It should be noted that this system leaves room for stage expansion because of the AVB Thru ports available on each of the EarMix 16M personal monitor mixers. These connections could be used for additional components that don't require PoE.

A separate LAN network has been created to remote control the three mixers using UC Surface and QMix-UC. It should be noted that any wireless device connected to the wireless router and running UC Surface or QMix-UC can be connected to any or all three mixers. Because of this, it is important to manage your user permissions. *For more information on User Permissions, please review the UC Surface and QMix-UC Reference Manuals.*

Network Connection Diagram

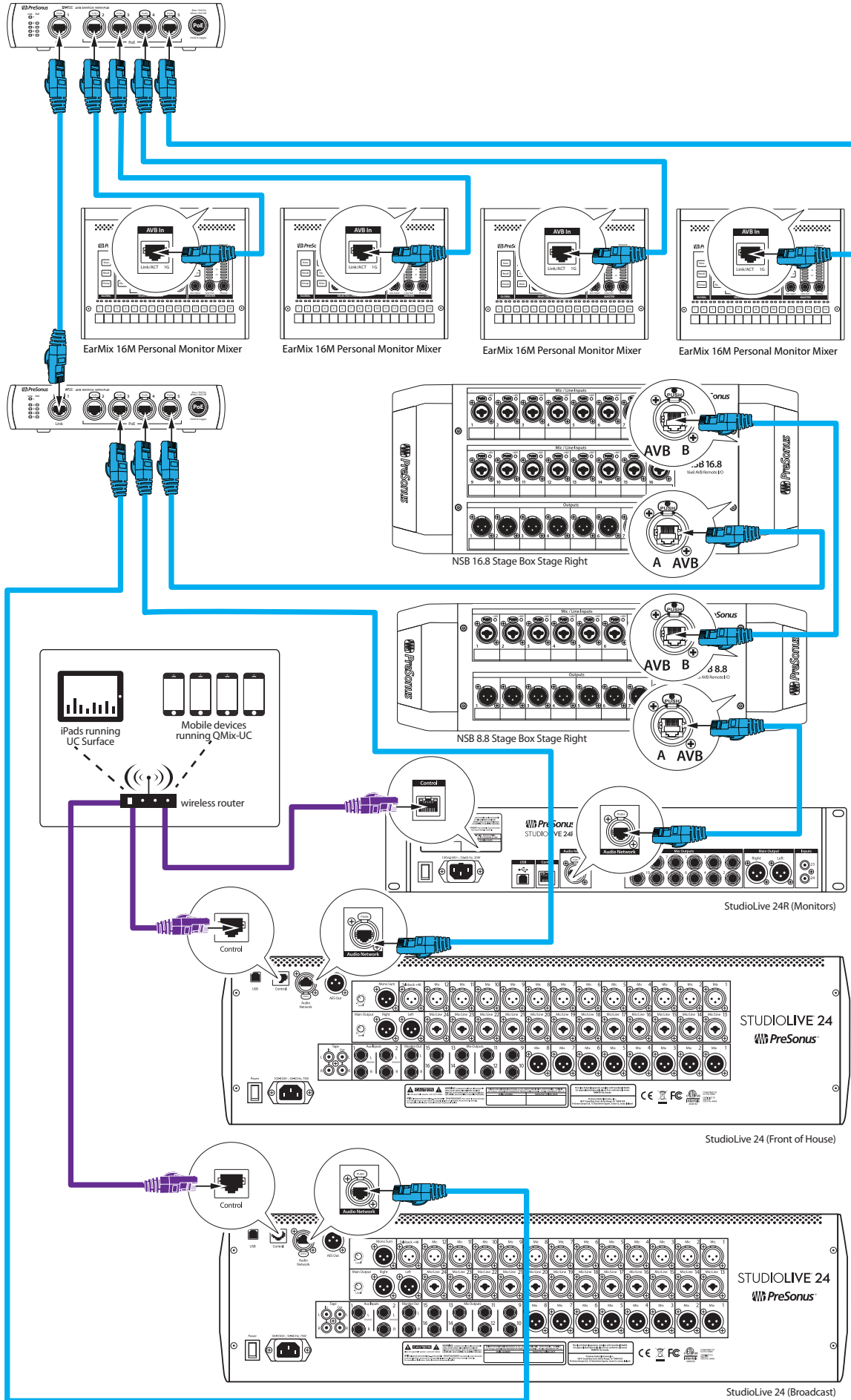

5.2.1 Connecting Your Mixers

Connecting the three StudioLive Series III mixers to this network is relatively straightforward. All that needs to be done is to place the StudioLive 24R into Monitor Mixer Mode and set the clock on the Broadcast mixer to the Network Stream, making the mixer at Front-of-House the master clock for the system. Please note that clocking for the StudioLive 24R is also coming from the mixer at Front-of-House. This setting is handled automatically by the system when Monitor Mixer Mode is engaged.

Changing Network Clock

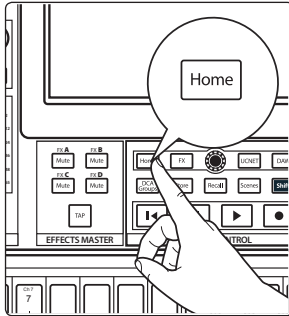

Changing the network clock can be done from the System menu. To begin, press the Home button on your StudioLive 24 broadcast mixer.

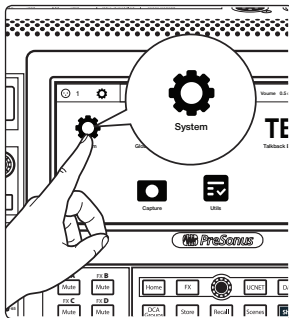

From the Home menu, press System.

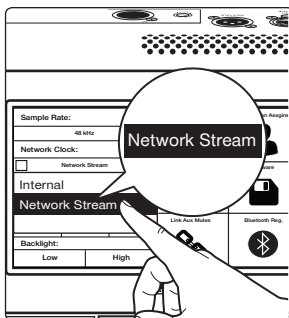

From the Network Clock menu, select Network Stream.

Note: The StudioLive 24 at Front-of-House must be connected to the Network and powered on to properly distribute clock. Additionally, an AVB stream must be connected to the Stream 1 input of the StudioLive 24 at broadcast as this is where network clock is derived.

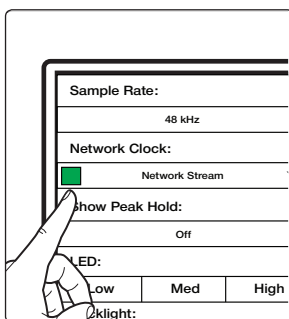

The Clock Status indicator to the left of the selected clock source will illuminate Green when your StudioLive mixer is properly synced.

Enabling Monitor Mixer Mode

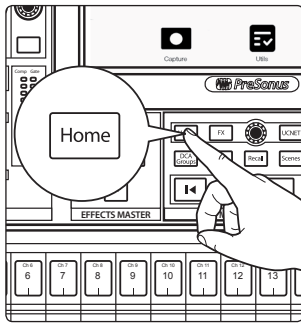

1. Press the Home button on your StudioLive Series III console at Front-of-House.

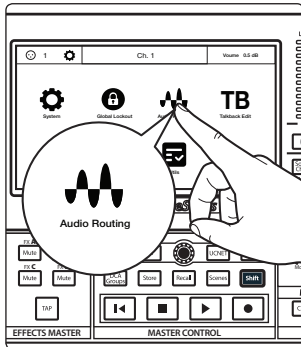

2. Press Audio Routing on the Home Screen.

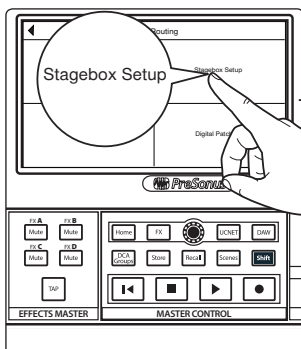

3. Press the Stagebox Setup button on the screen.

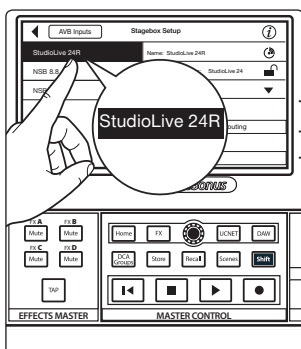

4. Select your rack mixer from the list at the left.

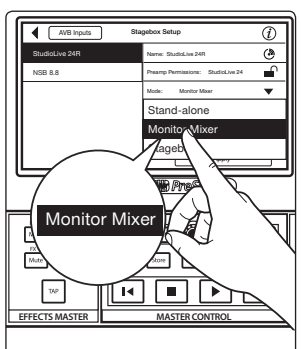

5. Select the Monitor Mixer Mode.

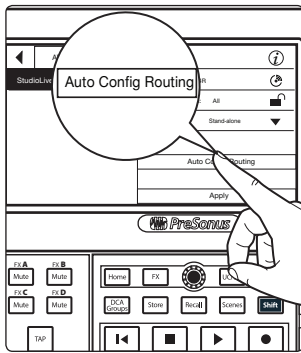

StudioLive Series III mixers route channels in banks of 8. From the AVB Inputs page, you can choose to auto-configure your routing as follows:

- Inputs 1-32 will be routed between the two networked mixers so that they are available on both. The Main Mix will be routed from the console mixer to the rack mixer, but the Flex Mixes will remain local to each mixer.

This is the configuration we will be using for our example.

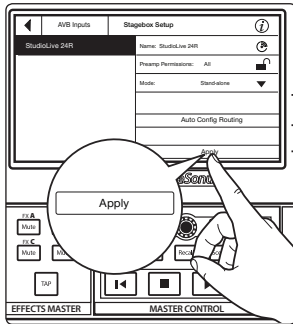

6. Tap Apply to save the mode.

Power User Tip: Connecting to your mixer and selecting the mode can be one or two steps. When Apply is pressed, both the selected mixer and the selected Stagebox Mode are saved simultaneously.

Your mixers are now connected and synced to each other over the network. Streams can be freely routed via the Digital Patching menu. **More information on Digital Patching can be found in the StudioLive Series III Owners Manual and the UC Surface Reference Manual.** The information in the rest of this tutorial only covers network routing as it relates to our example.

5.2.2 Connect Your NSB-series Stage Boxes to Your Console Mixers

Complete the steps in this section for both the StudioLive 24 at Front-of-House and at the Broadcast position.

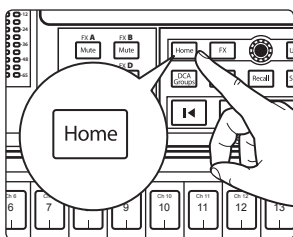

1. Press the Home button on the StudioLive 24.

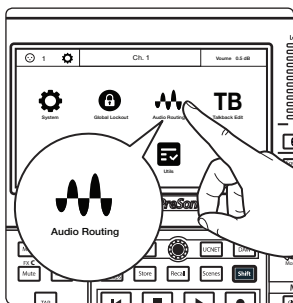

2. Press the Audio Routing icon on the Touchscreen.

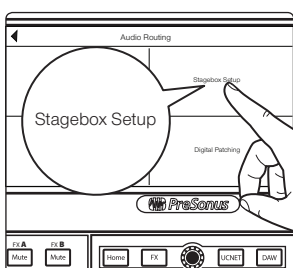

3. Press the Stagebox Setup button on the Touchscreen.

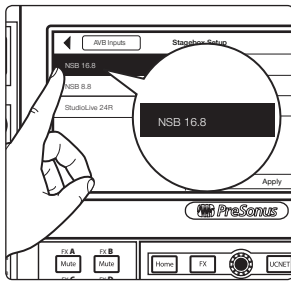

4. Select the NSB16.8 from the list on the left.

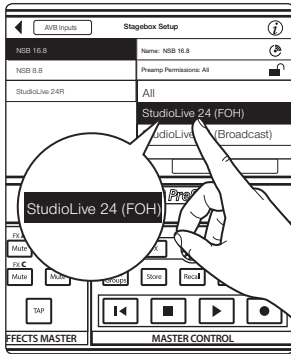

5. In our example, we will be giving preamp permissions for all devices to the StudioLive 24 at Front-of-House.

Power User Tip: Your StudioLive mixers can be given a custom name either from the UCNET Screen (console mixers) or from UC Surface. For more information, please review the StudioLive Series III Owners manual.

When you are done, repeat Steps 1-5 for the NSB 8.8.

Setting the Clock (NSB 16.8 only)

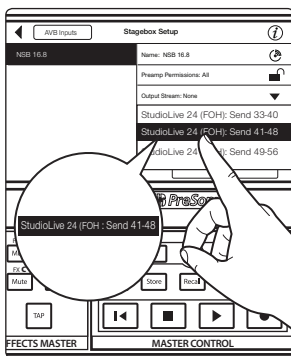

Select the StudioLive 24 (FOH) Sends 41-48 for the AVB Output Stream. This will be the clocksource for the NSB 16.8 as well as route the appropriate AVB Sends for our example. More information on AVB Output routing is covered in **Section 5.4**.

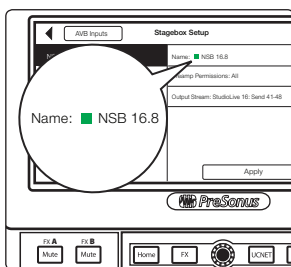

Power User Tip: Once send streams from your mixer have been successfully patched, you will see a green status indicator next to your NSB stage box in the setup screen indicating proper clocking.

Setting the Clock (NSB 8.8 only)

For the purposes of our example, the NSB 8.8 will be receiving Output streams from the StudioLive 24R and so will clock to that device. This will also patch the necessary Output Stream used in *Section 5.4*.

1. Launch UC Surface and connect to your StudioLive 24R.



2. Click or Tap on the Settings Gear.

3. Click or Tap on the Network tab.

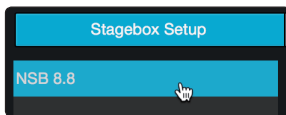
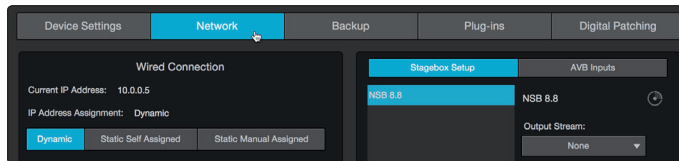

4. In the Stagebox Setup area, select the NSB8.8 from the list.

5. Select StudioLive 24R: AVB Sends 41-48 from the drop-down menu below 'Output Stream.'

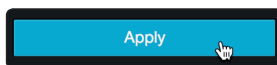
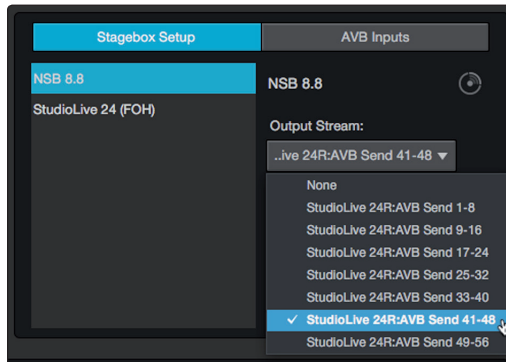

6. Press the Apply button when finished.

5.3 Analog Input Connections

Once your network is connected, the next step is to connect your analog devices. In our example is connected as follows:

Analog Input	Instrument	AVB Send	StudioLive 24 AVB Input Streams (FOH)	StudioLive 24 AVB Input Streams (Broadcast)	StudioLive 24R AVB Input Streams (Monitors)
NSB 8.8 In 1	Kick	NSB 8.8 Send 1-8 (GC)	Input 1-8	Input 1-8	Input 1-8
NSB 8.8 In 2	Snare	NSB 8.8 Send 1-8 (GC)	Input 1-8	Input 1-8	Input 1-8
NSB 8.8 In 3	High Hat	NSB 8.8 Send 1-8 (GC)	Input 1-8	Input 1-8	Input 1-8
NSB 8.8 In 4	Tom 1	NSB 8.8 Send 1-8 (GC)	Input 1-8	Input 1-8	Input 1-8
NSB 8.8 In 5	Tom 2	NSB 8.8 Send 1-8 (GC)	Input 1-8	Input 1-8	Input 1-8
NSB 8.8 In 6	Floor Tom	NSB 8.8 Send 1-8 (GC)	Input 1-8	Input 1-8	Input 1-8
NSB 8.8 In 7	Overhead Left	NSB 8.8 Send 1-8 (GC)	Input 1-8	Input 1-8	Input 1-8
NSB 8.8 In 8	Overhead Right	NSB 8.8 Send 1-8 (GC)	Input 1-8	Input 1-8	Input 1-8
NSB 16.8 In 1	Bass D.I.	NSB 16.8 Send 1-8 (GC)	Input 9-16	Input 9-16	Input 9-16
NSB 16.8 In 2	Lead Guitar	NSB 16.8 Send 1-8 (GC)	Input 9-16	Input 9-16	Input 9-16
NSB 16.8 In 3	Rhythm Guitar	NSB 16.8 Send 1-8 (GC)	Input 9-16	Input 9-16	Input 9-16
NSB 16.8 In 4	Acoustic Guitar D.I.	NSB 16.8 Send 1-8 (GC)	Input 9-16	Input 9-16	Input 9-16
NSB 16.8 In 5	Backing Vox 1	NSB 16.8 Send 1-8 (GC)	Input 9-16	Input 9-16	Input 9-16
NSB 16.8 In 6	Backing Vox 2	NSB 16.8 Send 1-8 (GC)	Input 9-16	Input 9-16	Input 9-16
NSB 16.8 In 7	Keys 1 Left	NSB 16.8 Send 1-8 (GC)	Input 9-16	Input 9-16	Input 9-16
NSB 16.8 In 8	Keys 1 Right	NSB 16.8 Send 1-8 (GC)	Input 9-16	Input 9-16	Input 9-16
NSB 16.8 In 9	Keys 2 Left	NSB 16.8 Send 9-16 (GC)	Input 17-24	Input 17-24	Input 17-24
NSB 16.8 In 10	Keys 2 Right	NSB 16.8 Send 9-16 (GC)	Input 17-24	Input 17-24	Input 17-24
StudioLive 24R In 1	Wireless Mic 1	StudioLive 24R: Send 1-8	Input 25-32	Input 25-32	Input 25-32
StudioLive 24R In 2	Wireless Mic 2	StudioLive 24R: Send 1-8	Input 25-32	Input 25-32	Input 25-32
StudioLive 24R In 3	Wireless Mic 3	StudioLive 24R: Send 1-8	Input 25-32	Input 25-32	Input 25-32
StudioLive 24R In 4	Wireless Mic 4	StudioLive 24R: Send 1-8	Input 25-32	Input 25-32	Input 25-32
StudioLive 24 (FOH) Aux 1 Left	DVD Left	StudioLive 24 (FOH): Send 1-8	n/a	Inputs 33-48	Inputs 33-48
StudioLive 24 (FOH) Aux 1 Right	DVD Right	StudioLive 24 (FOH): Send 1-8	n/a	Inputs 33-48	Inputs 33-48
StudioLive 24 (FOH) Talkback In	Talkback Mic	StudioLive 24 (FOH): Send 1-8	n/a	Inputs 33-48	Inputs 33-48

Audio Input Connection Diagram

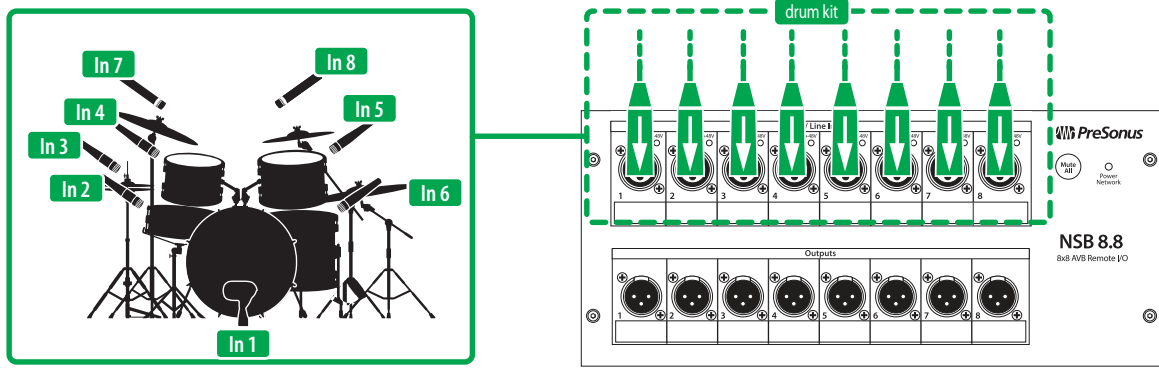

NSB 8.8 Stage Box Stage Right

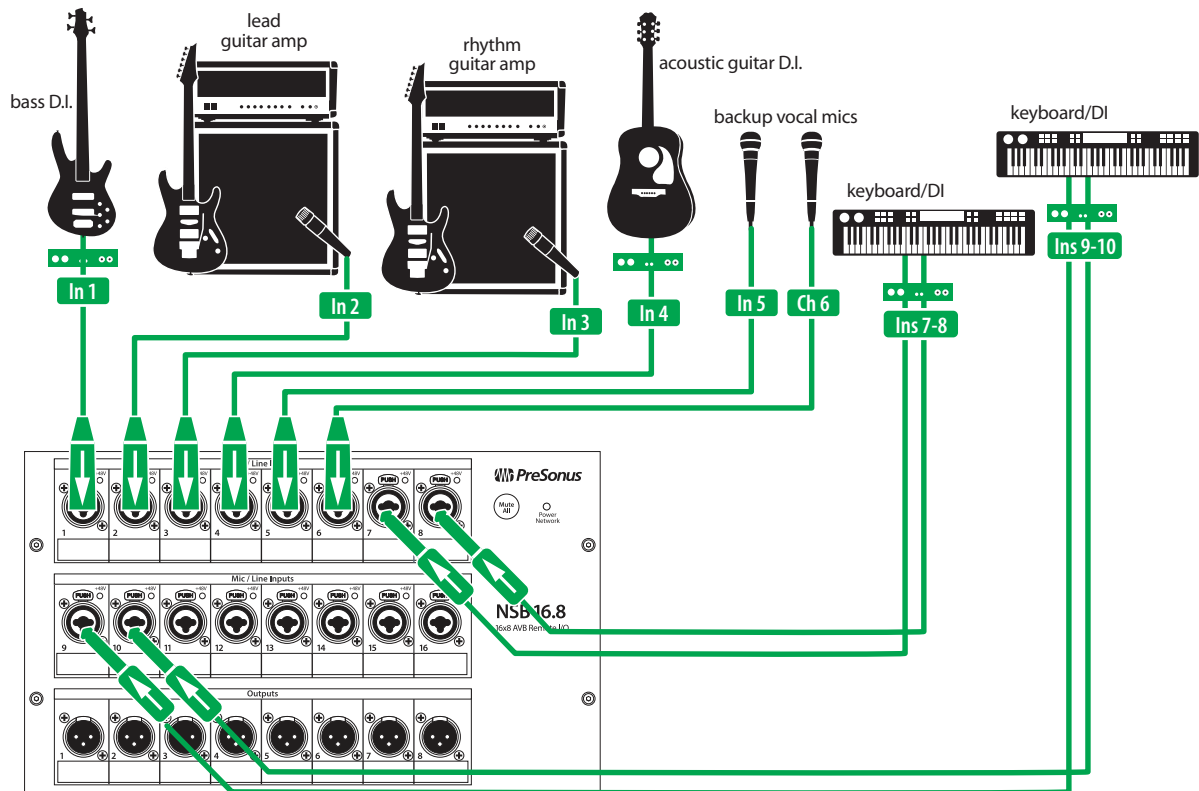

NSB 16.8 Stage Box Stage Right

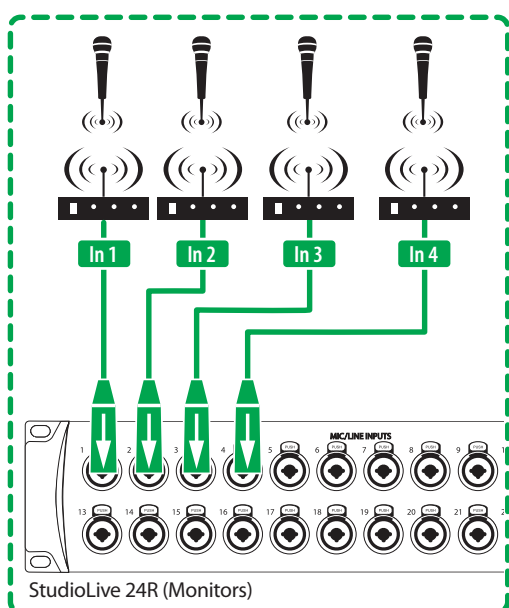

StudioLive 24R (Monitors)

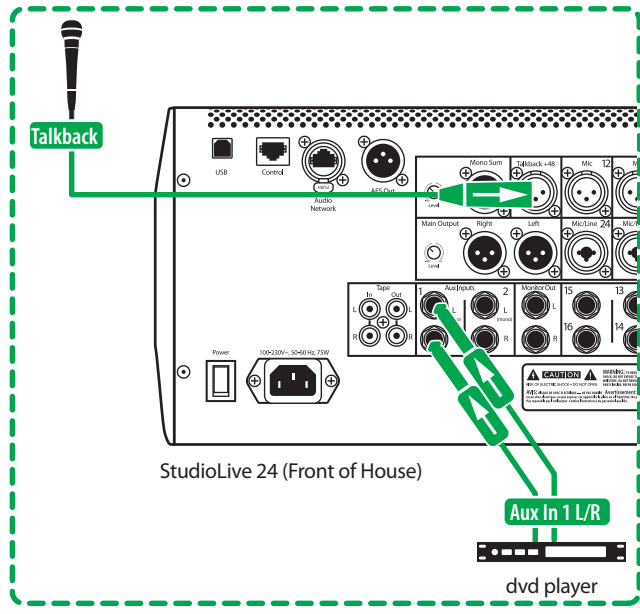

StudioLive 24 (Front of House)

Aux In 1 L/R

dvd player

5.3.1 Routing AVB Sends to Your Console Mixers

For brevity, this section will only show the basic routing from the first input to the NSB 8.8 to a console mixer. Channels from the NSB 16.8, the StudioLive 24R, and the StudioLive 24 at Front-of-House are routed in the same manner. The StudioLive 24 used for Broadcast should be configured exactly the same way as the StudioLive 24 at Front-of-House. **More information on NSB-series stage box features and functions can be found in the NSB-series Owners Manual.**

AVB Streams must be routed in banks of eight. The channels within these streams are patched as follows:

- **NSB-series.** NSB-series inputs are patched one-to-one to their AVB Sends (Input 1 is patched to AVB Send 1, Input 9 is patched to AVB Send 9, etc.).
- **StudioLive Mixers.** By default, mixer inputs are also patched one-to-one to their AVB Sends. However, mixer inputs can be freely routed to any destination via the Digital Patching menu.

Patching StudioLive 24 (FOH) Inputs to Their AVB Sends

Before we begin patching AVB Sends to the console mixer, we must first patch the analog inputs we want available to the network from the StudioLive 24 at Front-of-House to the AVB Sends we'd like to use (AVB Sends 1-8, in this case).

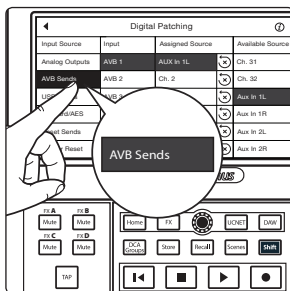

1. From the StudioLive 24 at Front-of-House, open the Digital Patching screen and press the AVB Sends tab. **For more information on Digital Patching, please review the StudioLive Series III Owners Manual.**

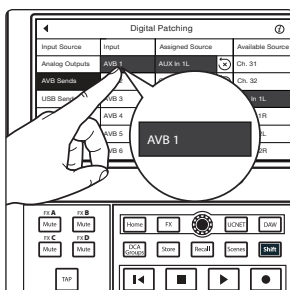

2. In the Inputs column, press AVB 1.

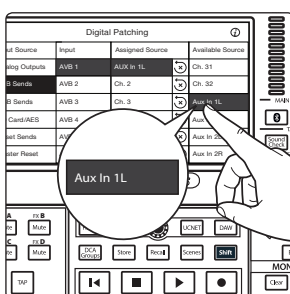

3. Select the Available Source column and use the value encoder to scroll to Aux In 1L.

Repeat Steps 1-3 to patch Aux 1R and the Talkback In to AVB Sends 2 and 3 respectively.

Power User Tip: While our example doesn't require this, it is important to note that using Digital Patching in the manner described above can be done for StudioLive rack mixers as well using the Digital Patching menu in UC Surface.

Patching AVB Sends

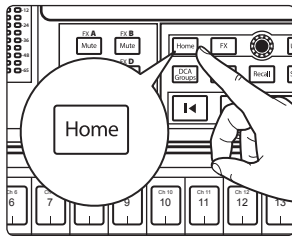

1. Press the Home button on your StudioLive Series III mixer.

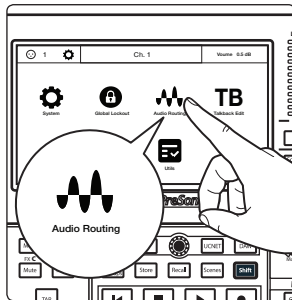

2. Press the Audio Routing icon on the Touchscreen.

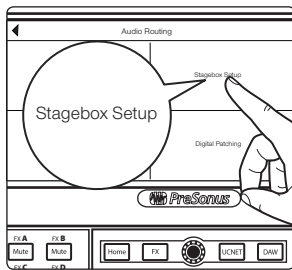

3. Press the Stagebox Setup button on the Touchscreen.

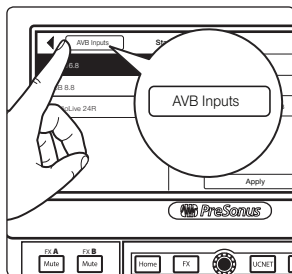

4. Press the AVB Inputs button.

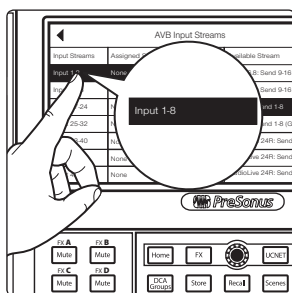

5. Select Inputs 1-8 from the Input Streams list.

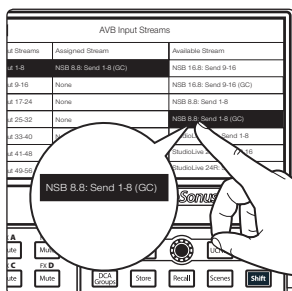

6. Select NSB 8.8: Send 1-8 (GC) from the Available Stream list to patch the first eight NSB 8.8 Gain Compensated inputs to the first eight AVB input streams on your mixer. **For more information on Gain Compensation, please review the NSB-series Owners manual.**

Continue routing your AVB Streams to your mixer streams using the table at the beginning of Section 5.3 as your guide.

5.3.2 Routing the NSB-series Inputs to Your StudioLive 24R

For brevity, this section will only show the basic routing from the first input to the NSB 8.8 to the StudioLive 24R. Channels from the NSB 16.8 as well as the StudioLive 24 (FOH) channels are routed in the same manner. *More information on StudioLive 24R as a monitor mixer, please review the StudioLive Series III Stagebox Mode Addendum.*

1. Click on the AVB Inputs tab.



2. Next to Inputs 1-8, select NSB 8.8: Send 1-8 (GC) from the Available Stream drop-down menu. This will patch the eight inputs on your NSB 8.8 to channels 1-8 on your StudioLive 24R.

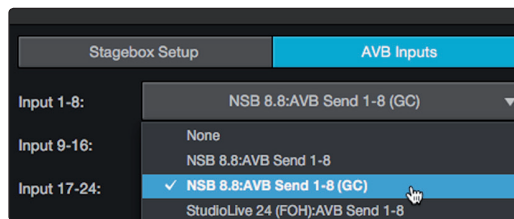

Continue routing your AVB Streams to your mixer streams using the table at the beginning of [Section 5.3](#) as your guide.

5.3.3 Routing Audio to the Console Mixers

In our example, we will be routing the audio sources as follows. For simplicity, we will be routing the audio sources the same on every mixer:

Mixer Channel	Source	Physical Input
Channel 1	Kick	NSB 8.8 In 1
Channel 2	Snare	NSB 8.8 In 2
Channel 3	High Hat	NSB 8.8 In 3
Channel 4	Tom 1	NSB 8.8 In 4
Channel 5	Tom 2	NSB 8.8 In 5
Channel 6	Floor Tom	NSB 8.8 In 6
Channel 7	Overhead Left	NSB 8.8 In 7
Channel 8	Overhead Right	NSB 8.8 In 8
Channel 9	Bass	NSB 16.8 In 1
Channel 10	Lead Guitar	NSB 16.8 In 2
Channel 11	Rhythm Guitar	NSB 16.8 In 3
Channel 12	Acoustic Guitar	NSB 16.8 In 4
Channel 13	Wireless Mic 1 (lead vocals)	StudioLive 24R In 1
Channel 14	Wireless Mic 2	StudioLive 24R In 2
Channel 15	Wireless Mic 3	StudioLive 24R In 3
Channel 16	Wireless Mic 4	StudioLive 24R In 4
Channel 17	Backing Vocals 1	NSB 16.8 In 5
Channel 18	Backing Vocal 2	NSB 16.8 In 6
Channel 19	Keys 1 Left	NSB 16.8 In 7
Channel 20	Keys 1 Right	NSB 16.8 In 8
Channel 21	Keys 2 Left	NSB 16.8 In 9
Channel 22	Key 2 Right	NSB 16.8 In 10
Channel 23	DVD Left	StudioLive 24 (FOH) Aux 1L
Channel 24	DVD Right	StudioLive 24 (FOH) Aux 1R
Talkback	Talkback	StudioLive 24 (FOH) Talkback

Note: The DVD and Talkback will be routed to their default channels on the StudioLive 24 at Front-of-House. This will allow the FOH engineer to use their Talkback system as well as simplify the routing.

Rerouting Sources in UC Surface

In our example, we are using the default settings for most audio routing. Because of this, we only need to reroute the four inputs on the StudioLive 24R to alternative channels so that these sources on are the same channels on every mixer. To do this, open the Digital Patching menu in UC Surface and navigate to the Input Patch screen.

From the Input Patch tab, select Analog to view your Analog sources and patch Inputs 1-4 to Channels 13-16 using the routing matrix.

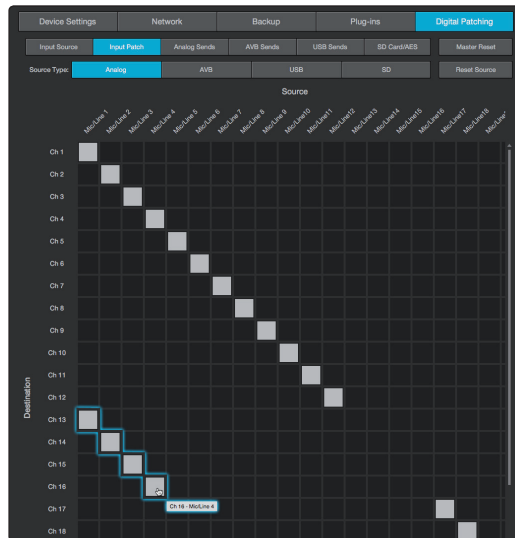

5.4 Analog Output Connections

For simplicity, the diagram below only shows the outputs that are being sourced from the network. Obviously, in a system as complex as the one used in this example, other local outputs would be put to use.

The floor wedges in our example are used as backup systems for the four EarMix 16M and are being fed independent mixes from the StudioLive 24R.

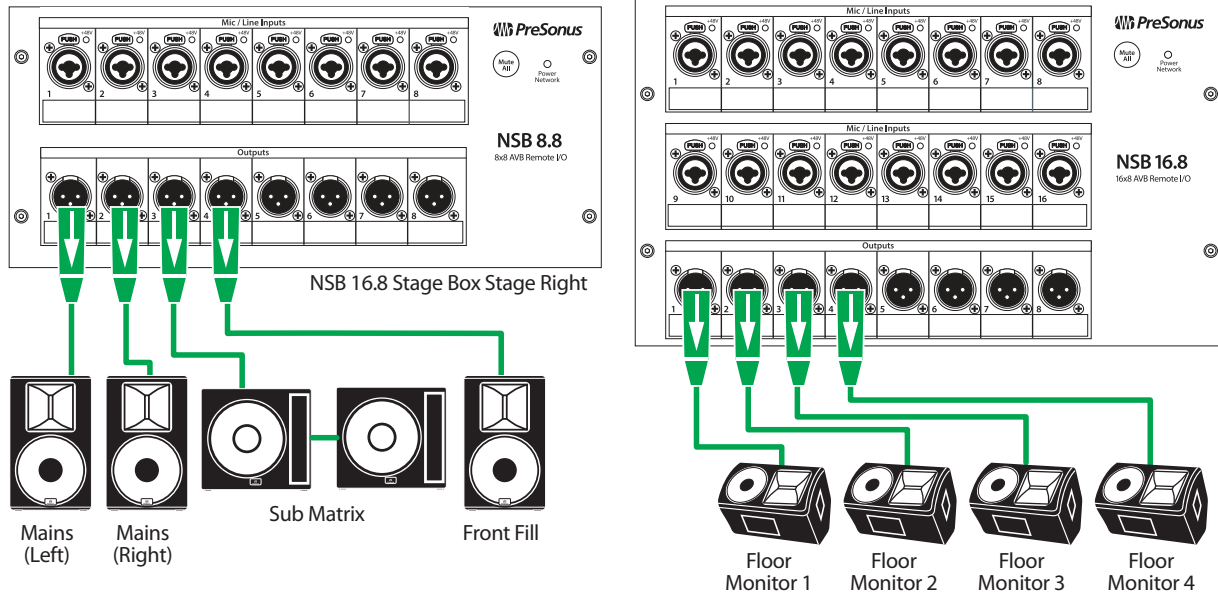

5.4.1 Routing the Main Outputs

In Section 5.2.2, we routed AVB Sends 1-8 from the StudioLive 24 at Front-of-House to the NSB 16.8 on stage. In this section, we will be routing the appropriate mixes to each AVB Send as follows:

Mix	AVB Send	NSB 16.8 Output
Main Mix Left	AVB Send 41	NSB 16.8 Out 1
Main Mix Right	AVB Send 42	NSB 16.8 Out 2
Subgroup Matrix Mix (Subgroup A)	AVB Send 43	NSB 16.8 Out 3
Front Fill (FlexMix 1)	AVB Send 44	NSB 16.8 Out 4

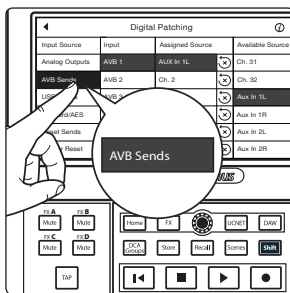

- From the StudioLive 24 at Front-of-House, open the Digital Patching screen and press the AVB Sends tab. *For more information on Digital Patching, please review the StudioLive Series III Owners Manual.*

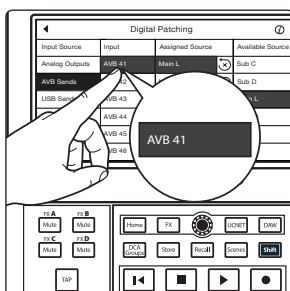

- In the Inputs column, press AVB 41.

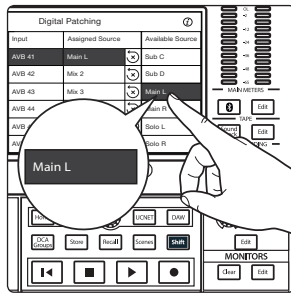

3. Select the Available Source column and use the value encoder to scroll to Main L.

Repeat Steps 1-3 to patch Main R, Sub A and FlexMix 1 to AVB Sends 42-44 respectively.

5.4.2 Routing Monitor Mixes

In Section 5.2.3, we routed AVB Sends 1-8 from the StudioLive 24R to the NSB 8.8 on stage. In this section, we will be routing the appropriate mixes to each AVB Send as follows:

Mix	AVB Send	NSB 8.8 Output
Monitor Mix 1 (FlexMix 1)	AVB Send 41	NSB 8.8 Out 1
Monitor Mix 2 (FlexMix 2)	AVB Send 42	NSB 8.8 Out 2
Monitor Mix 3 (FlexMix 3)	AVB Send 43	NSB 8.8 Out 3
Monitor Mix 4 (FlexMix 4)	AVB Send 44	NSB 8.8 Out 4

No additional set-up is required. By default, FlexMixes 1-4 are routed to AVB Sends 41-44.

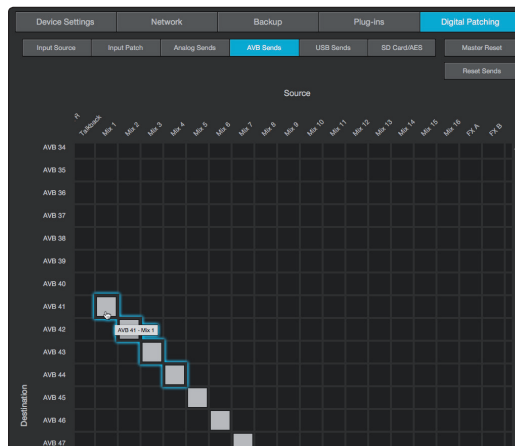

5.5 EarMix Setup

In our example, all channels and mixes for all four EarMix 16M personal monitor mixers will be routed from the StudioLive 24R. We will be summing down the 25 channels to 16 channels as follows:

EarMix 16M Channel	Instrument	StudioLive 24R Source	AVB Sends
Channel 1	Drum Mix L	Flex Mix 5	StudioLive 24R Send 25
Channel 2	Drum Mix R	Flex Mix 6	StudioLive 24R Send 26
Channel 3	Bass	Channel 9	StudioLive 24R Send 27
Channel 4	Lead Guitar	Channel 10	StudioLive 24R Send 28
Channel 5	Rhythm Guitar	Channel 11	StudioLive 24R Send 29
Channel 6	Acoustic Guitar	Channel 12	StudioLive 24R Send 30
Channel 7	Wireless Mic 1 (lead vocals)	Channel 13	StudioLive 24R Send 31
Channel 8	Wireless Mic 2	Channel 14	StudioLive 24R Send 32
Channel 9	Wireless Mic 3	Channel 15	StudioLive 24R Send 33
Channel 10	Wireless Mic 4	Channel 16	StudioLive 24R Send 34
Channel 11	Backing Vocals 1	Channel 17	StudioLive 24R Send 35
Channel 12	Backing Vocal 2	Channel 18	StudioLive 24R Send 36
Channel 13	Keys 1 Left	Channel 19	StudioLive 24R Send 37
Channel 14	Keys 1 Right	Channel 20	StudioLive 24R Send 38
Channel 15	Keys 2 Left	Channel 21	StudioLive 24R Send 39
Channel 16	Key 2 Right	Channel 22	StudioLive 24R Send 40

5.5.1 Routing AVB Streams to Your EarMix 16M

From the EarMix Setup screen in UC Surface, route AVB Send 25-32 to 1-8 Source and AVB Send 33-40 to 9-16 Source for each EarMix 16M on the network.

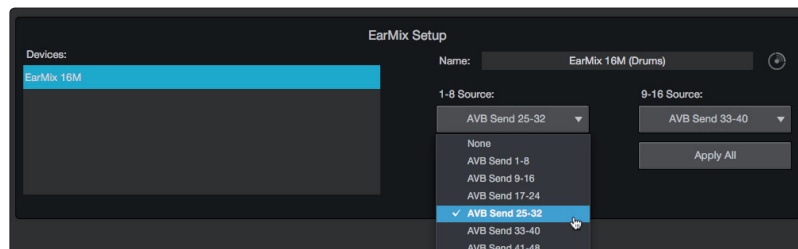

5.5.2 Routing StudioLive 24R Sources to AVB Sends

The next step is to route the necessary channels and buses to the appropriate AVB sends using the Digital Patching menu in UC Surface.

From the AVB Sends tab, you will route the input channels and mixes to their respective AVB Sends as described in the table at the beginning of Section 5.5.



Added bonus: PreSonus' previously Top Secret recipe for...

Jambalaya

Ingredients:

- 5 lbs link andouille sausage
- 3 lbs boneless chicken
- 2 lbs ground beef
- 3 lbs onions (yellow or purple)
- 2 stalks of celery
- 1 lb bell peppers (green or red)
- 1 batch green onions
- 3 lbs rice
- Tony Chachere's Cajun Seasoning
- 1 bottle chicken stock concentrate (or 3 cubes chicken bullion)
- 1 can Rotel tomatoes with chilies, diced (regular hot)
- Tabasco sauce

Cooking Instructions:

1. In a 16 qt. pot or larger, slice link sausage and pan-fry until brown.
2. Add ground beef and brown.
3. Do not remove from pot Add diced onions, celery, and bell peppers, 1 can Rotel Original diced tomatoes with chilies, 3 oz concentrate chicken stock, ½ teaspoon of Cajun seasoning, 1 teaspoon of Tabasco hot sauce (or more...maybe lots more).
4. Cook until onions are translucent.
5. Add chicken and cook until it turns white.
6. Add diced green onions, 1 tsp. salt, ½ gallon water and bring to a boil.
7. Add rice and bring to a boil. Cook on high for 8 minutes, covered, stirring every 2 minutes
8. Cook covered on low for 10 minutes, stirring only once.
9. Turn off and let sit for 30 minutes.
10. Serve and enjoy!

Serves 20

StudioLive™ Series III

AVB Networking Guide

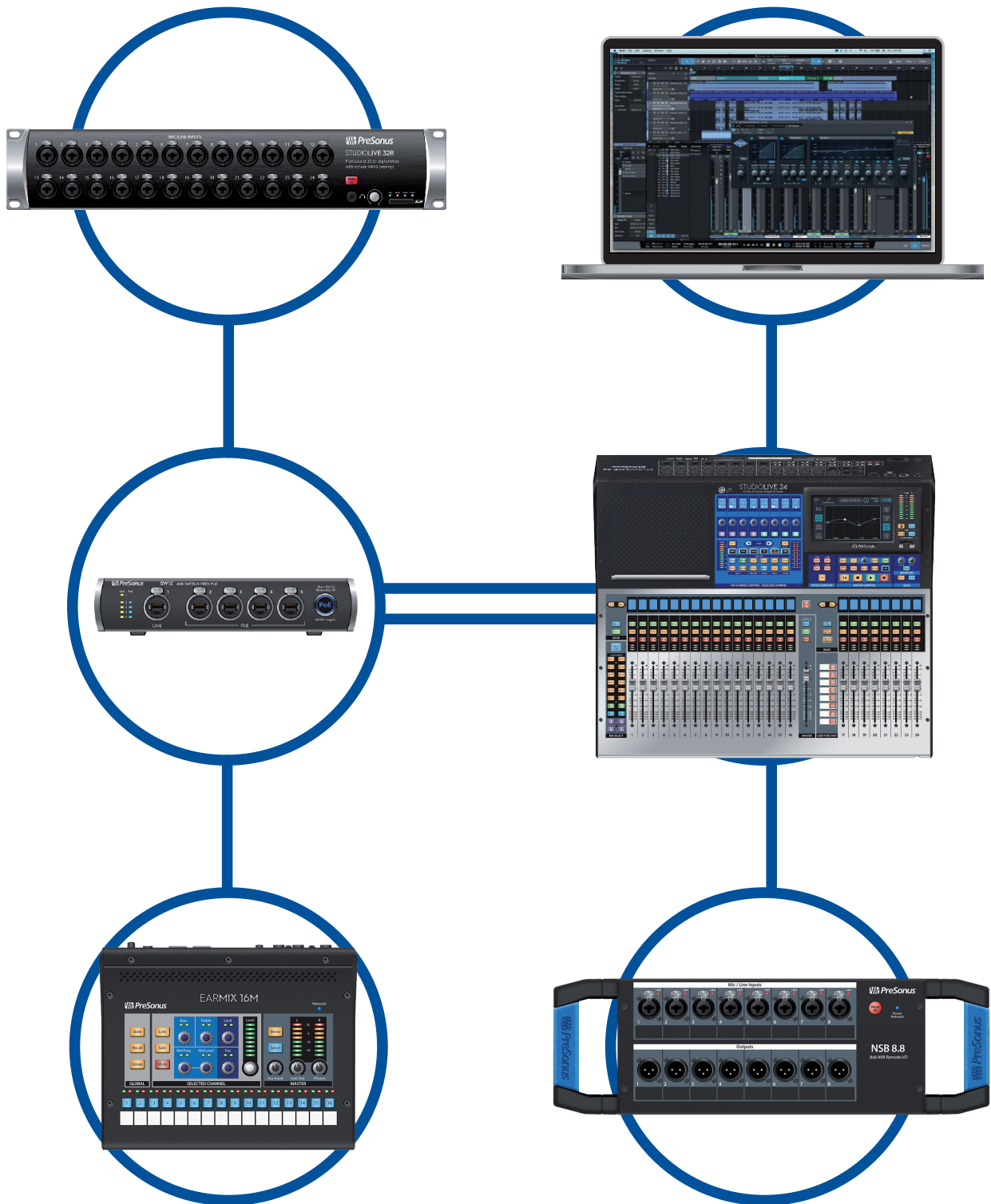

18011 Grand Bay Ct. • Baton Rouge,
Louisiana 70809 USA • 1-225-216-7887
www.presonus.com

Part# 70-22000106-A