

# UC Surface

## Software Reference Manual



UC Surface

# Table of Contents

## 1 Introduction — 1

### 1.1 About This Manual — 1

## 2 Mix Controls — 3

### 2.1 Selecting Your Mix — 3

### 2.2 Copy Mix — 4

### 2.3 Input Channel Controls — 5

#### 2.3.1 Channel Strip — 5

#### 2.3.2 Channel Detail — 5

#### 2.3.3 Channel Settings — 7

### 2.4 Mix Detail — 8

#### 2.4.1 Aux and Matrix Mix Detail — 8

#### 2.4.2 Subgroup Mix Detail — 9

### 2.5 Filter DCAs — 10

#### 2.5.1 Creating, Editing, and Deleting Filter DCAs — 11

#### 2.5.2 Group Masters — 12

## 3 Fat Channel Controls — 13

### 3.1 Noise Gate — 13

#### 3.1.1 Key Filter Sidechaining — 14

### 3.2 Compressor — 15

### 3.3 Equalizer — 16

### 3.4 Limiter — 17

## 4 Graphic EQ — 18

### 4.1 Enabling Smaart Analysis (StudioLive AI-series only) — 19

#### 4.1.1 Time-Frequency Spectrograph — 19

#### 4.1.2 RTA — 20

### 4.2 Using the Smaart Spectrograph to Ring Out Monitors — 20

### 4.3 Using the RTA While Mixing — 21

## 5 Adding Effects — 22

### 5.1 Editing Effects — 22

## 6 Presets — 23

### 6.1 Fat Channel Presets — 23

### 6.2 GEQ Presets — 24

### 6.3 FX Presets — 24

### 6.4 Preset Management — 25

## 7 Projects and Scenes — 26

### 7.1 Project and Scene Management (StudioLive Series III) — 26

#### 7.1.1 Import /Export — 27

### 7.2 Mix Scenes (StudioLive AI-series) — 28

#### 7.2.1 Quick Scenes — 28

#### 7.2.2 Scenes Library — 29

#### 7.2.3 Scene Safe Edit — 29

## 8 Quick Panel Functions — 31

### 8.1 Talkback — 31

#### 8.1.1 Talkback Destination — 31

#### 8.1.2 Talkback Source (StudioLive Rack Mixers) — 32

### 8.2 Mute Groups — 32

### 8.3 FX Mutes — 33

### 8.4 Fader Locate (StudioLive AI-series Console Mixers only) — 33

## 9 The Settings Page — 34

### 9.1 Device Settings — 34

#### 9.1.1 Device Permissions — 34

#### 9.1.2 Configure Lockout (StudioLive AI Console Mixers) — 37

#### 9.1.3 Firmware — 37

#### 9.1.4 System Settings — 38

### 9.2 Networking — 43

#### 9.2.1 Wired Connection — 43

#### 9.2.2 Stagebox Setup (StudioLive Series III only) — 44

- 9.2.3 EarMix Setup  
(StudioLive Series III only) — **45**
- 9.2.4 Wireless Connection  
(StudioLive AI-series only) — **45**
- 9.2.5 Cascading Mixers  
(StudioLive RM/RML mixers) — **45**
- 9.3 Backup — **46**
- 9.4 Plug-ins (StudioLive Series III Mixers) — **46**
- 9.5 User Profiles (StudioLive Series III Mixers) — **47**
  - 9.5.1 Default Administrator — **47**
  - 9.5.2 Creating a New Profile — **48**
  - 9.5.3 Edit User Permissions — **49**
- 9.6 Digital Patching  
(StudioLive Series III only) — **50**
  - 9.6.1 Input Source — **50**
  - 9.6.2 Input Patch — **51**
  - 9.6.3 Analog Sends — **51**
  - 9.6.4 AVB Sends — **52**
  - 9.6.5 USB Sends — **53**
  - 9.6.6 SD Sends — **53**
  - 9.6.7 AES — **54**
- 9.7 Aux Routing (StudioLive AI-Series Mixers) — **54**
- 9.8 Smart System Check Wizards  
(StudioLive AI-series only) — **55**
  - 9.8.1 Smart Room Analysis Wizard — **56**
  - 9.8.2 Smart System Delay Wizard — **58**
  - 9.8.3 Smart Output Check Wizard — **61**
  - 9.8.4 Mic Position — **61**
  - 9.8.5 System Alignment Rules — **64**
  - 9.8.6 Using the Trace:  
Spotting the Trend — **64**

## **10 StudioLive Series III Rack Mixer SD Recording — 68**

- 10.1 Recording a New Capture Session — **68**
- 10.2 Capture Screen — **69**
- 10.3 Recording Status Indicators — **69**
  - 10.3.1 Status — **69**
  - 10.3.2 Recording Errors — **70**

## 1 Introduction

UC Surface is a powerful software application that provides control of channel, subgroup, aux, and bus levels; Fat Channel parameters; aux mixes; effects; and graphic EQs. It also provides a visual overview of your StudioLive settings so that you can see, adjust, and organize them, as well as a librarian, allowing you to easily manage your presets and scenes.

For StudioLive Series III and AI-series console mixers, UC Surface provides bidirectional control that allows you to remote-control mixing functions that are also available from their respective hardware control surfaces. Since control is bidirectional, fader moves and parameter changes made on the StudioLive mixing surface are reflected in UC Surface and vice versa.

For StudioLive Series III rackmount mixers and StudioLive AI-series RM and RML mixers, UC Surface provides software-only control.

**Power User Tip:** *The StudioLive CS18AI hardware controller for StudioLive AI-series RM/RML mixers can be used in conjunction with UC Surface.*

UC Surface will run on macOS, Windows, and Windows Touch computers, as well as Android devices and iPads affording flexible control options for any mix situation.

To use UC Surface, you must do one of two things:

- Connect your StudioLive, computer, Android device, or iPad to the same wireless network. This option will allow you to use any or all of these devices to remote control your StudioLive mixer anywhere in the venue
- Connect and sync your StudioLive to your computer using your computer's host transport (USB, FireWire s800, or Thunderbolt). This option allows you to use UC Surface while recording and playing back audio through Capture™, Studio One®, or a third-party DAW of your choice.

**Note:** *StudioLive AI-series mixers support the use of the Apple Thunderbolt to FireWire adapter.*

### 1.1 About This Manual

We suggest that you use this manual to familiarize yourself with UC Surface before trying to use it to control your mixer. This guide assumes that you have followed the networking procedures outlined in the **Networking for StudioLive Remote Control Guide**. If you are using UC Surface on a Mac or Windows computer, you must first install Universal Control. Please refer to the **Using Your StudioLive as an Audio Interface with Universal Control Reference Guide** for installation instructions.

Throughout this manual, you will find **Power User Tips**. These tips provide useful hints on how to best use UC Surface and take advantage of unique workflow functions and features.

For the most part, StudioLive Series III and AI-series console and rack mixers behave identically. Because of fundamental architectural differences, some functionality is not available in every series and style of mixer. When these differences occur, it will be noted as follows:

- **StudioLive Series III mixers:** All StudioLive Series III console and rack mixers.
  - **StudioLive Series III console mixers:** StudioLive 64S, StudioLive 32S, StudioLive 32SX, StudioLive 32SC, StudioLive 32, StudioLive 24, and StudioLive 16
  - **StudioLive Series III rack mixers:** StudioLive 16R, StudioLive 24R, and StudioLive 32R
- **StudioLive AI-Series mixers:** All StudioLive AI-series console and rack mixers.
  - **StudioLive AI-Series console mixers:** 16.4.2AI, 24.4.2AI, and 32.4.2AI
  - **StudioLive AI-Series RM/RML mixers:** RM16AI, RM32AI, RML16AI, and RML32AI



This guide explains the functions and basic routing features of the audio interface onboard your StudioLive mixer. The following companion guides are also available:

#### Hardware Guides:

- **StudioLive Series III Console Mixer Owner's Manual.** Use this reference guide to understand all the hardware functions on your StudioLive Series III console mixer (StudioLive 64S, StudioLive 32S, StudioLive 32SX, StudioLive 32SC, StudioLive 32, StudioLive 24, and StudioLive 16).
- **StudioLive Series III Rackmount Mixer Owner's Manual.** Use this reference guide to understand all the hardware functions on your StudioLive Series III rackmount mixer (StudioLive 32R, StudioLive 24R, StudioLive 16R).
- **StudioLive AI-Series Console Mixer Owner's Manual.** Use this reference guide to understand all the hardware functions on your StudioLive AI-Series console mixer (StudioLive 32.4.2AI, StudioLive 24.4.2AI, StudioLive 16.4.2AI).
- **StudioLive AI-Series Rackmount Mixer Owner's Manual.** Use this reference guide to understand all the hardware functions on your StudioLive AI-Series rackmount mixer (StudioLive RM/RML32, StudioLive RM/RML16).

#### Software Guides:

- **Capture 3 Reference Manual.** Included with StudioLive mixers is Capture, a digital-audio multitrack-recording application designed to make recording quick and easy.
- **Networking for StudioLive Remote Control.** This guide will assist you in creating a LAN network to remote control your StudioLive from a computer, tablet, or mobile device.
- **QMix-UC Reference Manual.** This guide describes the features and functions of QMix-UC with every StudioLive mixer model. QMix-UC lets up to 16 users remotely control the Aux Mixes on your StudioLive using their smartphone.
- **Studio One Integration Reference Manual.** Studio One Artist is included with every StudioLive mixer. In addition to being a powerful DAW, Studio One provides unique routing and integration features. This manual will help you get the most from your StudioLive mixer when used with Studio One or Studio One Artist.
- **Using Your StudioLive as an Audio Interface with Universal Control Reference Guide.** This guide describes the features and functions Universal Control as well as how to use your StudioLive mixer as an audio interface with your favorite DAW application.

#### Additional Resources:

- **StudioLive Series III AVB Networking Guide.** This manual covers advanced AVB audio networking configuration for the StudioLive Series III mixers.
- **StudioLive Series III HUI for ProTools DAW Control Addendum.** StudioLive Series III console mixers can control Avid ProTools® using HUI emulation.
- **StudioLive Series III MCU for Logic DAW Control Addendum.** StudioLive Series III console mixers can control Apple Logic® using Mackie Control Universal.
- **StudioLive Series III Stage box Mode Addendum.** The StudioLive Series III rackmount mixers can be used as advanced stageboxes for StudioLive Series III console mixers.
- **StudioLive Series III Studio One DAW Control Addendum.** StudioLive Series III console mixers can be used to control Studio One and Studio One Artist.

## 2 Mix Controls

UC Surface provides a single window interface that allows you to quickly view every mix.

### 2.1 Selecting Your Mix



The Mix Select buttons allow you to choose the mix you'd like to control (Auxes, Mains, Subgroups). In addition, UC Surface provides a mix for each of the effects buses. The returns for these effects are available in each mix to customize the amount of reverb and delay.

#### Flex Fader



The fader immediately to the left of the Mix Select buttons controls the output level of the currently selected mix.

### Main Fader



The fader(s) to the right of the Mix Select buttons always control(s) the Main mix level.

- **StudioLive 64S.** When connected to a StudioLive 64S, three faders will be visible. The Mono and Main faders control the output level of their respective buses, while the Master fader is a grouped level control for both.
- **StudioLive AI-series RM/RML.** When connected to StudioLive AI-series RM and RML mixers, a mono bus fader will also be visible.

## 2.2 Copy Mix

Copying the current mix allows you to quickly set up multiple mixes based on the settings you've already completed.



1. To copy a mix to any other mix, press the Copy Mix button.
2. Click on the desired destination mix(es).
3. Click Paste to paste the mix or click Cancel to stop the operation.

## 2.3 Input Channel Controls

### 2.3.1 Channel Strip

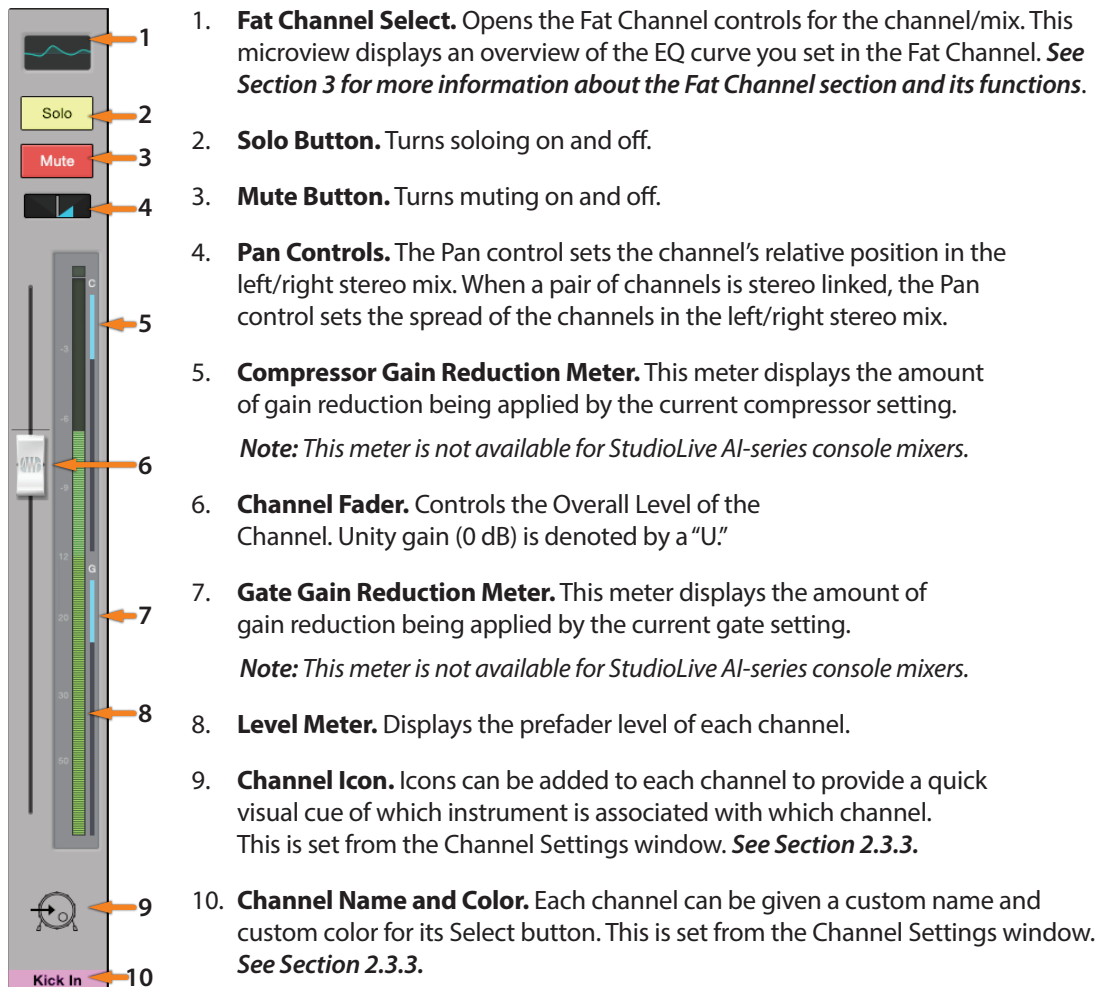

### 2.3.2 Channel Detail

When an input channel is selected, the following controls will be available at the far left of the Fat Channel:

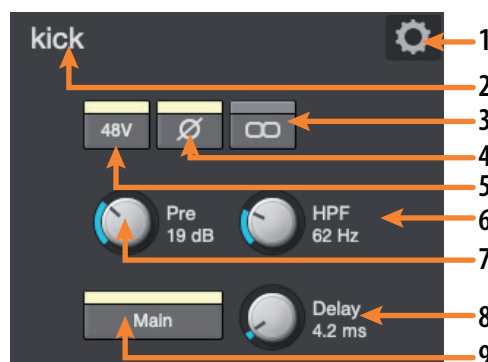

1. **Channel Settings.** Opens Channel Settings view. *See Section 2.3.3 for details.*
2. **Channel Name.** To give each channel a custom name, simply click on the default name to open a text field.
3. **Link.** Enables/disables stereo link.



When a pair of channels is stereo linked, a toggle control is provided to the left of the Channel Settings button so that you can toggle between the left and right channel to access preamp controls for each.

4. **Polarity.** This button will illuminate when polarity is inverted on the current channel.

***Power User Tip:** The Polarity control inverts the polarity of the selected channel's preamp signal by 180°. The Polarity button can be used to correct audio signals that are out of phase relative to each other, which causes frequency cancellation and reinforcement. When recording with more than one open microphone, you may need to invert the polarity to combat phase cancellation between microphones.*

5. **Phantom Power** Enables/disables phantom power for the currently selected channel.

6. **High-Pass Filter.** Sets the High-Pass Filter Frequency Threshold for the Selected Channel or Output Bus. The filter's threshold can be set from 24 Hz to 1 kHz. When the meter is set to its lowest point, the filter is off. The high-pass filter is available on all input channels and on auxiliary and FX output buses only.

***Power User Tip:** A high-pass filter attenuates all frequencies below the set threshold. Use the Fat Channel high-pass filter to remove unwanted low frequencies from your source signal, rather than trying to EQ them out.*

7. **Mic Preamp Trim.** A trim control is provided for all input channels to adjust the gain of your digitally controlled XMAX preamps.

***Note:** This control is not available for StudioLive AI-series console mixers as these mixers are not equipped with digitally recallable mic preamps.*

8. **Input Delay (StudioLive Series III mixers only).** Sets the alignment delay for the currently selected channel. For more information on using an Input Delay, *please review the StudioLive Series III Owners Manual.*

9. **Main Bus Assign.** Use this button to assign the current channel to the main bus. Additional bus controls are as follows:

- **StudioLive 64S:** Main Mono/Center
- **StudioLive Series III mixers (32-channel models):** Main Mix, Subgroups A-D
- **StudioLive AI-series consoles:** Main Mix, Subgroups 1-4
- **StudioLive AI-series RM/RML mixers:** Main Mix, Mono

***Note:** StudioLive RM-series and Series III mixers offer flexible mix functionality that allows you to make any FlexMix function as an aux bus or subgroup. Please see Section 2.4.2 for channel routing to a FlexMix subgroup.*

### 2.3.3 Channel Settings



When a channel is selected, the Settings icon for that channel is visible in the left side

of the Fat Channel.

After pressing the Settings icon, the following controls will be available at the far left of the Fat Channel:

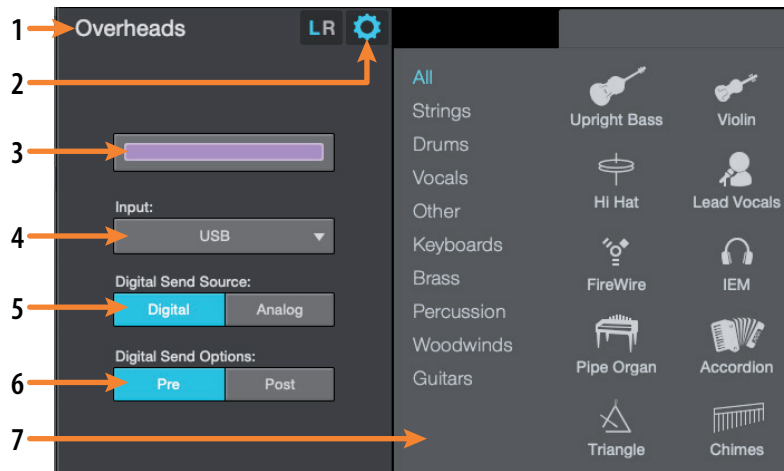

1. **Channel Name.** Click or touch to edit the channel name.
2. **Exit.** Click or touch to exit the Channel Settings view.
3. **Color.** Click or touch to set a custom color for the current channel.

***Power User Tip:** Creating colors for different channel types is a great way to visually group channels, allowing you to quickly identify a channel by type (drums, guitars, vocals, etc.). You can choose to color the entire channel strip or just the channel name. See Section 9.1.4 for details.*

4. **Input Source.** This drop-down menu allows you to select the source for the current channel. The following options are available:
  - **StudioLive Series III:** Analog, Network, USB, or SD Card
  - **StudioLive AI consoles:** Analog or FireWire
  - **StudioLive RM-series:** Analog, FireWire, or Network
5. **Set Pre- / Post-Processing Send.** Select Pre- or Post-Fat Channel processing for digital sends for each channel.
6. **Digital Send Source (StudioLive Series III only).** This allows you to select source input of the digital send for each channel.
7. **Apply a Channel Type and Icon.** Clicking on the Channel Type button lets you apply a category and icon for your channel. Channels in the same category will automatically be placed into the same Filter DCA Group (*See Section 2.6 for details*).

## 2.4 Mix Detail

### 2.4.1 Aux and Matrix Mix Detail



When a mix is selected, the following controls will be available at the far left of the Fat Channel:

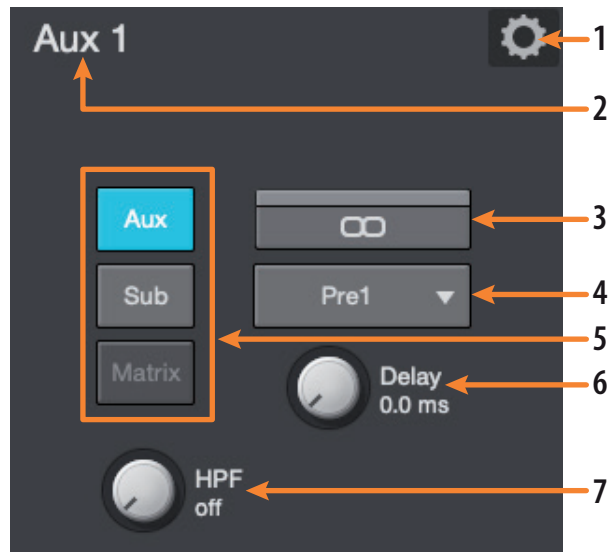

1. **Mix Settings.** Opens Mix Settings View. *See Section 2.5 for details.*
2. **Mix Name.** To give each mix a custom name, simply click on the default name to open a text field.
3. **Stereo Link.** Creates a stereo bus with the adjacent FlexMix.
4. **Aux Send Position.** By default, all aux buses are set to Pre 1. This places the send of every input channel to each aux bus before the fader, limiter, EQ, and compressor, but after the Polarity switch, high-pass filter, and gate.  
The four internal effects buses are set to Pre 2 by default, which routes each of the input channels after all Fat Channel dynamics and EQ but prefader.  
From this menu, you can choose between three send positions for each Aux and FX mix:
  - **Pre 1:** Sends each channel to the aux bus after the polarity invert, high-pass filter, and gate.
  - **Pre 2:** Sends each channel to the aux bus after all Fat Channel processing (polarity invert, high-pass filter, gate, compressor, EQ, and limiter) but before the fader.
  - **Post:** Sends each channel to the aux bus after all Fat Channel processing (polarity invert, high-pass filter, gate, compressor, EQ, and limiter) and after the fader.

*Power User Tip: Use the Pre 2 position for headphone and in-ear mixes to give your performers a polished “studio” sound. This setting should be avoided for floor wedges, as compression can cause feedback problems.*
5. **Bus Type (Series III and RM-series mixers only).** StudioLive Series III and AI-series RM/RML mixers’ feature FlexMixes that can be configured as aux mixes, subgroups, or matrix mixes (Series III only). Use these buttons to select the bus type. *See Section 2.4.2 for information on routing channels to FlexMix subgroups.*
6. **Output Delay (StudioLive Series III only).** Sets the alignment delay for the current FlexMix. For more information on using output delays, *please review the StudioLive Series III Owners Manual.*
7. **High-Pass Filter.** Sets the High-Pass Filter Frequency Threshold for the Selected Channel or Output Bus. The filter’s threshold can be set from 24 Hz to 1 kHz. When the meter is set to its lowest point, the filter is off. The high-pass filter is available on all input channels and on auxiliary and FX output buses only.

*Power User Tip: A high-pass filter attenuates all frequencies below the set threshold. Use the Fat Channel high-pass filter to remove unwanted low frequencies from your source signal, rather than trying to EQ them out*

### 2.4.2 Subgroup Mix Detail

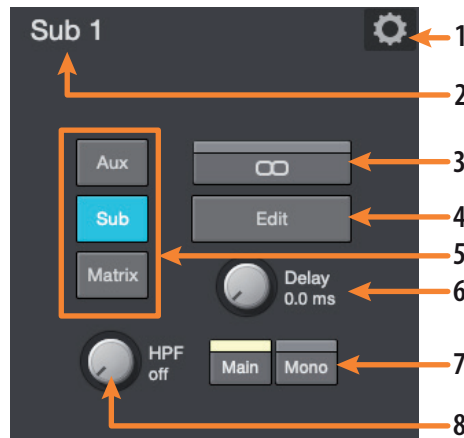

1. **Mix Settings.** Opens Mix Settings view. *See Section 2.5 for details.*
2. **Mix Name.** Click or tap on the default name to open a text field to customize the mix name.
3. **Stereo Link.** Click or tap to create a stereo subgroup with the adjacent FlexMix.
4. **Subgroup Edit.** Click or tap to add or remove channels from the subgroup.
5. **Bus Type (Series III and RM-series mixers only).** StudioLive Series III and AI-series RM/RML mixers' feature FlexMixes that can be configured as aux mixes, subgroups, or matrix mixes (Series III only). Use these buttons to select the bus type.
6. **Output Delay (StudioLive Series III only).** Sets the alignment delay for the current FlexMix. For more information on using output delays, *please review the StudioLive Series III Owners Manual.*
7. **Route to Main.** Click or tap to route the subgroup to the Main bus. StudioLive 645 users will also find a Mono assign for the Mono/Center bus.
8. **High-Pass Filter.** Sets the High-Pass Filter Frequency Threshold for the Selected Channel or Output Bus. The filter's threshold can be set from 24 Hz to 1 kHz. When the meter is set to its lowest point, the filter is off. The high-pass filter is available on all input channels and on auxiliary and FX output buses only.

*Power User Tip: A high-pass filter attenuates all frequencies below the set threshold. Use the Fat Channel high-pass filter to remove unwanted low frequencies from your source signal, rather than trying to EQ them out*

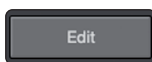

When a FlexMix subgroup is selected, you will find the Edit button in the Mix Detail area of the Fat Channel. Clicking this button will allow you to route input channels to this subgroup.

Click on the channels you would like assigned to the subgroup. The channel will

highlight as it is selected, indicating that it has been routed to the subgroup.

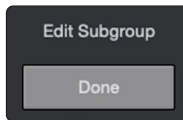
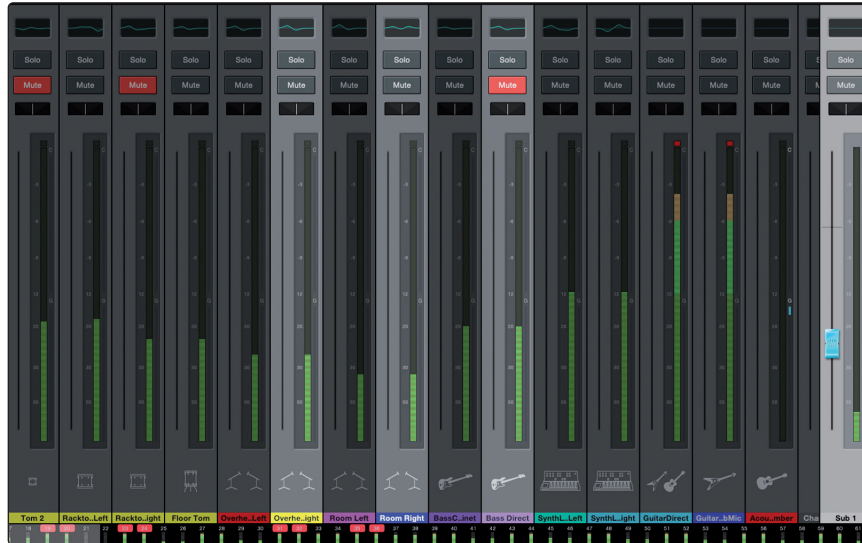

Click the Done button when you've assigned the desired channels

## 2.5 Filter DCAs

Professional mixing consoles have addressed the problem of managing complex mixes with population groups that reduce the channels you're viewing at one time and DCAs that control the overall level of a group of channels.

We've combined the best aspects of these solutions with Filter DCAs. A Filter DCA can contain any combination of the available input channels and effects returns, and you can create up to 24 Filter DCA groups as you need. You can even include the same channel in multiple Filter DCAs so you can manage mixes in multiple ways. Each group is given a master level control so you can control the overall level of the group while maintaining each channel's relative balance in the mix. In this way, for example, you can create a single fader to control every drum in a monitor mix and maintain the relative level of the drum mix that you created.

Once selected, a Filter DCA group stays active until exited regardless of which mix is selected. This allows you to adjust the group independently across different mixes. You can also flip between groups on the fly to change the view of a selected mix.

**Note:** Filter DCAs are not available for StudioLive AI-series console mixers.

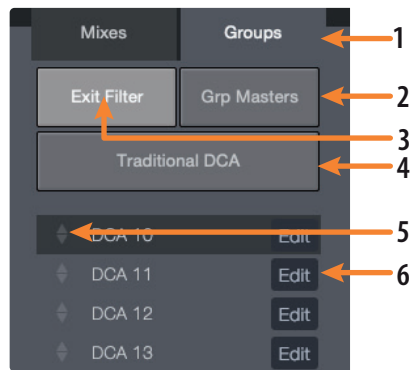

1. **Groups Tab.** Opens Filter DCA list.
2. **Group Masters.** Displays only the Master fader for every Filter DCA.
3. **Exit Filter.** The Exit Filter button will be visible as soon as a Filter DCA is selected. In this way, you can exit the Filter DCA and view all the channels in your mix.
4. **Traditional DCA.** When controlling the master level a DCA Group, the faders for the channels assigned to that group will move to more accurately provide a visual indication of the actual level of each channel in the group. This feature can be defeated by enabling "Traditional DCA" mode.
5. **Reorder.** Moves Filter DCA up or down in the list.
6. **Edit Filter DCA.** Opens Edit mode options (Rename, Add/Remove Channels, Delete).

### 2.5.1 Creating, Editing, and Deleting Filter DCAs

There are two ways a Filter DCA group can be created.

- **Auto-created Filter DCA Groups.** When a channel is assigned a Channel Type, UC Surface automatically creates a Filter DCA group based on that information. For example, when you define a channel type within in the Drums category for any channel in your mix, a Drums group will be added to the Filter DCAs. Auto Filter DCA groups are displayed in the bottom part the Filter DCA group list with a "~" in front of their names. These Filter DCAs can be hidden from the System Preferences page. *See Section 8.1.4.*
- **User-created Filter DCA Groups.** You can create new Filter DCA groups from scratch or by editing an existing Auto Filter DCA group. Any number of channels can be added to a group, and you can create as many groups as you wish. User-created groups are always shown at the top of the Filter DCA group list above the automatically generated groups.

#### To create a new Filter DCA group:



1. Click/tap the Group tab in the Mixer Selection area.



2. Select the Filter DCA you would like use and then click/tap the Edit button to enter Edit mode. From here you can add and remove channels as necessary.

- You'll notice all the channel strips in the mixer are darkened. Click or tap on the channels you'd like to add to your Filter DCA.

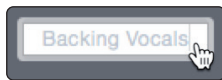
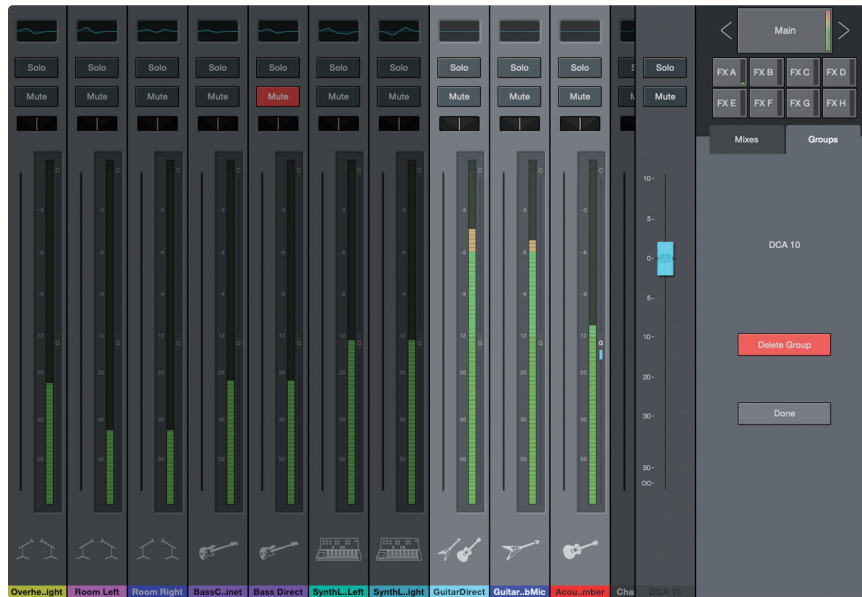

- You can customize the name of your new Filter DCA by clicking or tapping on the default name (New Filter DCA).

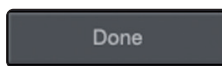

- Click or tap on the Done button when you are finished editing.

### Editing and Deleting Filter DCAs

Filter DCAs can be edited or deleted at any time by clicking or tapping the Edit (#6) button in the list view.

### Managing Filter DCAs

You can reorder the Filter DCA list by clicking or tapping on the Reorder (#5) button to the left of it and then clicking or tapping the Reorder button next to the position to which you would like it to move.

## 2.5.2 Group Masters

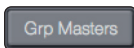

The Group Masters button allows you to view only the Master fader for every Filter DCA. Soloing or muting a group master will solo or mute all the channels in its group.

**Power User Tip:** The Group Masters view can be a great way for musicians to manage their own mix. For example, they can manage the drums as an entire group, their vocal mix, the overall band mix, etc., rather than managing individual channels.

### Spill Group



While the Group Masters are active, you will see the Spill Group button on top of each master fader. Clicking or tapping this button will spill the group, allowing you to see all the channels in the group and adjust their level, pan, or Fat Channel settings. While in Spill Group, the Flex fader will control the master level of the group regardless of which mix you select.

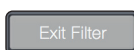

To close this view, click or tap on the Exit Filter button.

### 3 Fat Channel Controls

Every input and bus on your StudioLive mixer is equipped with Fat Channel dynamics processing and filtering. The revolutionary Fat Channel is the heart of the StudioLive. The Fat Channel makes dynamics, routing, and panning for every input and output on the StudioLive available at the touch of a Select button.

The Fat Channel's processing section consists of five parts: High-Pass Filter, Noise Gate, Compressor, Limiter, and parametric EQ. Each can be turned on or off and controlled separately. This processing is global across all mixes.

The signal flows as follows:

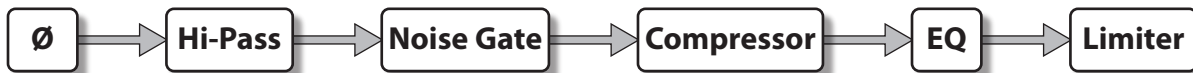

**Note:** For StudioLive AI-series mixers, when HD mode (88.2 or 96 kHz sample rate) is active, Fat Channel processing is disabled on all output buses.

StudioLive Series III mixers allow you to swap the positions of the Compressor and EQ stages of the Fat Channel.

**Power User Tip:** Placing the compressor before the EQ allows you to make dramatic changes to the EQ settings without needing to alter the compressor setting. However, if you place the EQ before the compressor, you can better control different frequencies, achieving a more natural response.

#### 3.1 Noise Gate

To view the controls for the Noise Gate, click on the Gate tab.

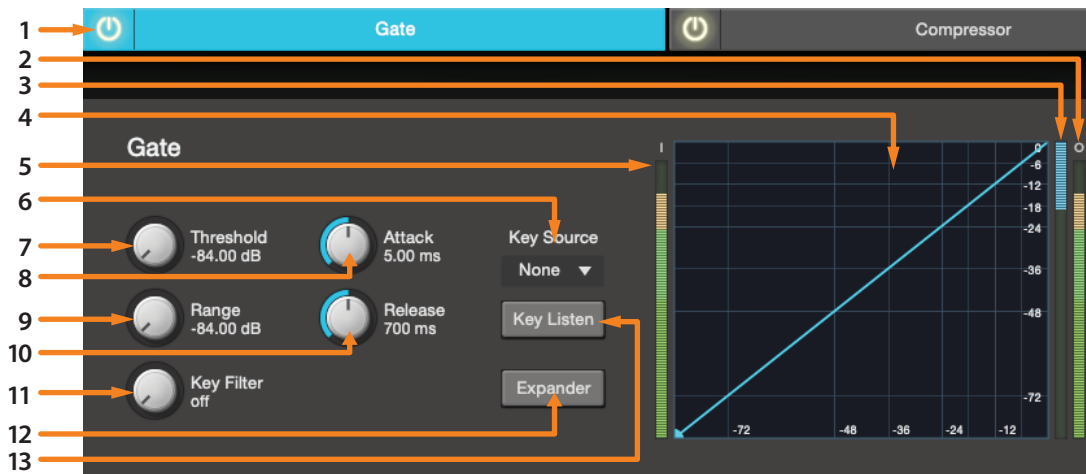

**Note:** The Noise Gate is available on the input channels only.

1. **Gate On/Off Button.** Engages/disengages the gate for the selected channel.
2. **Output Meter (Series III only).** Displays the post-Gate output signal.
3. **Gain Reduction Meter (Series III only).** Displays the amount of gain reduction being applied to the signal by the gate.
4. **Gate Graph.** This graph shows the point at which the gate threshold affects the signal. You can either use this graph to adjust the threshold or the dedicated threshold control (#7).
5. **Input Meter (Series III only).** Displays the input signal to the Gate.
6. **Key Source (Series III only).** Sets the trigger source for the gate's Key Filter. See the StudioLive Series III Owner's Manual for more information on sidechaining.



7. **Gate Threshold.** Sets the level at which the gate opens. Essentially, all signals above the threshold setting are passed through unaffected, whereas signals below the threshold setting are reduced in level by the amount set by the range control. You can set the threshold from 0 to -84 dB.
8. **Gate Attack.** Sets the rate at which the gate opens on the selected channel or output. A fast attack rate is crucial for percussive instruments. Slow-rising signals such as vocals and bass guitar require a slower attack; with these signals, a faster attack can cause an audible click. All gates have the ability to click when opening but a properly set gate will never click. You can set the attack time from 0.02 to 500 ms.
9. **Gate Range.** Sets the amount of gain reduction that the gate will produce. The range can be set from 0 to -84 dB.

*Note: Range control is not available when using the Expander.*

10. **Gate Release.** Sets the rate at which the gate for the selected channel closes. Gate-release times should typically be set so that the natural decay of the instrument or vocal being gated is not affected. Shorter release times help to clean up the noise in a signal but may cause “chattering” with percussive instruments. Longer release times usually eliminate chattering and should be set by listening carefully for the most natural release of the signal. The release time can be set from 0.05 to 2 seconds.
11. **Gate Key Filter.** Sets the frequency at which the gate will open. Setting a specific frequency, in addition to a specific decibel level, provides more sonic shaping. The Key Filter can be triggered by the selected channel or bus’s signal or by side-chaining a channel and using its signal as the source.

*Power User Tip: A properly set key filter on a gate can greatly improve the overall sound quality of a mix. For example, if you are inserting a gate on a snare-drum mic, you may get enough bleed from the kick drum to open the gate. This is where a key filter can come in handy. By setting the key filter to remove some of those low frequencies, the gate won’t be as apt to open for the kick drum.*

12. **Gate Expander Button.** StudioLive mixers allow you to choose between an expander and a noise gate for each channel or output. By default, the Expander button will be enabled.

*Power User Tip: In practice, expanders and noise gates are used almost identically. The main difference is that an expander is smoother and more gradual, so that it is easier to set the attack and release times correctly.*

13. **Key Listen.** Enable to listen to the signal being used to trigger the gate.

### 3.1.1 Key Filter Sidechaining

As previously mentioned, the key filter can be sidechained to another channel. Sidechaining has many uses. You can use a sidechained key filter to tighten up a rhythm section by sidechaining the kick drum channel to the bass channel and setting the gate to open at the frequency of the kick drum. This, combined with a fast attack and release, will make your rhythm section more cohesive. Increase the release time to loosen the feel. Please note that while sidechaining the kick drum to the bass channel can tighten up a good rhythm section and make them sound even better, it will not correct timing issues and will actually exaggerate them if your bass player and drummer aren’t in the pocket.

Another great use for a sidechain is as an effect in electronic music production. Try sidechaining a drum loop to a sustained source, like pads or strings. By doing this, every time a drum hit triggers the key filter, your sustained source will be heard. Between hits, this source will be silenced. Playing with the attack and release will transform this effect from a rhythmic pulse all the way to a chopped-up stutter.

3.2 Compressor

To view the controls for the Compressor, click on the Compressor tab.

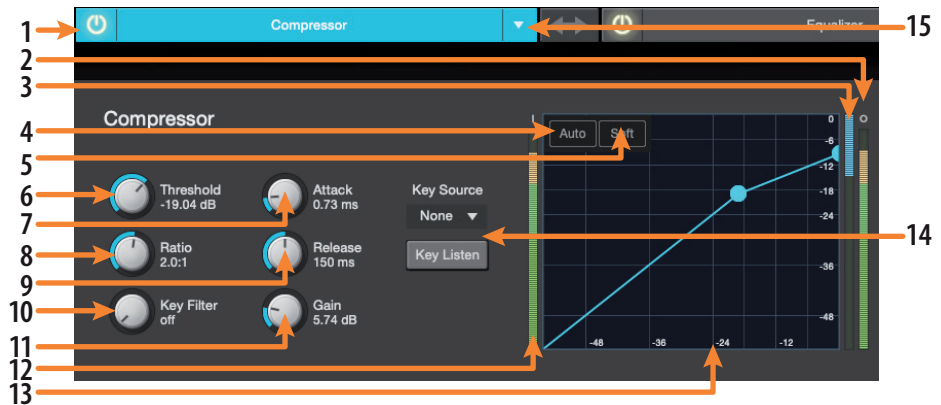

1. **Compressor On/Off.** Turns the Compressor On and Off for the selected channel.
2. **Output Meter (Series III only).** Displays the post-Compressor output signal.
3. **Gain Reduction Meter (Series III only).** Displays the amount of gain reduction being applied to the signal by the compressor.
4. **Auto Mode Button.** When Auto mode is active, the Attack and Release controls become inoperative, and a preprogrammed attack and release curve is used. In this mode, the attack is set to 10 ms, and the release is set to 150 ms. All other compressor parameters can still be adjusted manually.
5. **Soft Knee Toggle Button.** Engages Soft-Knee Compression. In normal operating mode, the compressor is set for hard-knee compression, meaning that the gain reduction applied to the signal occurs as soon as the signal exceeds the threshold. When the Soft Knee button is engaged, the onset of gain reduction occurs gradually after the signal has exceeded the threshold.
6. **Compressor Threshold.** Sets the compressor threshold for the selected channel or output bus. When the signal's amplitude (level) exceeds the threshold setting, the compressor engages. The threshold can be set from -56 to 0 dB.
7. **Compressor Attack.** Sets the compressor attack for the selected channel. Attack sets the speed at which the compressor acts on the input signal. A slow attack time (fully clockwise) allows the beginning component of a signal (commonly referred to as the initial transient) to pass through, uncompressed, whereas a fast attack time (fully counterclockwise) triggers compression immediately when a signal exceeds the threshold. You can set the attack from 0.2 to 150 milliseconds.
8. **Ratio.** Sets the compression ratio (or slope) for the selected channel or output bus. The ratio sets the compression slope, which is a function of the output level versus the input level. For example, if you have the ratio set to 2:1, any signal levels above the threshold setting will be compressed at a ratio of 2:1. This means that for every 2 dB of level increase above the threshold, the compressor's output will only increase 1 dB. The ratio can be set from 1:1 to 16.8:1 and finally Limiter.
9. **Compressor Release.** Sets the compressor release for the selected channel or output bus. Release sets the length of time the compressor takes to return the gain reduction back to zero (no gain reduction) after crossing below the compression threshold. Release can be set from 2.5 to 900 milliseconds.

***Power User Tip:** Very short release times can produce a choppy or "jittery" sound, especially when compressing instruments that have a lot of low-frequency components, such as bass guitar. Very long release times can result in an overcompressed, or "squashed," sound. All ranges of release can be useful, however, and you should experiment to become familiar with different sonic possibilities.*

10. **Key Filter.** Sets the frequency at which the compressor will engage. The compressor will still process the entire frequency range, but it is only engaged when the specified frequency is present.
11. **Compressor Makeup Gain.** Sets the amount of makeup gain for the selected channel or output bus. When compressing a signal, gain reduction usually results in an overall attenuation of level. The gain control allows you to restore this loss in level and readjust the volume to the pre-compression level (if desired). You can adjust Makeup Gain from 0 dB (no gain adjustment) to +28 dB.
12. **Input Meter (Series III only).** Displays the input signal to the compressor.
13. **Compressor Graph.** This graph shows the point at which the compressor threshold affects the signal. You can use this graph to adjust the threshold or use the dedicated Threshold control (#6).
14. **Key Source (Series III only) and Key Listen.** Sets the Key Source for the Compressor and allows you to monitor it.
15. **Compressor Type (Series III only).** This drop-down menu allows you to select the compressor type for the current channel.

### 3.3 Equalizer

To view the controls for the parametric EQ, click on the Equalizer tab.

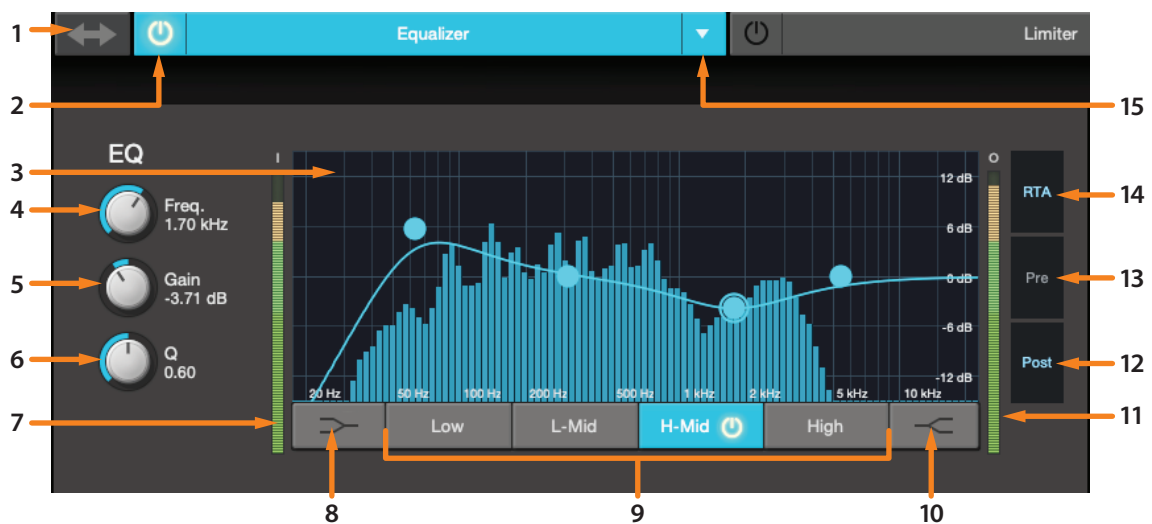

1. **EQ > Compressor.** This button moves the EQ before the Compressor.
2. **Equalizer On/Off.** Turns the EQ on or off for the selected channel.
3. **EQ Graph.** This graph shows overall EQ curve.
4. **EQ Frequency.** Adjusts the center frequency of each band.
5. **EQ Gain.** Sets level of the center frequency from -15 to +15 dB.
6. **Q.** Sets the Q for each band. The Q is the ratio of the center frequency to the bandwidth. When the center frequency is constant, the bandwidth is inversely proportional to the Q, so as you raise the Q, you narrow the bandwidth.
7. **Input Meter (Series III only).** Displays the pre-Fat Channel input signal.
8. **Low Shelf EQ On/Off.** Enabling the Low Shelf button turns the Low band into a shelving EQ. A low shelving EQ is like a bass-control knob on a stereo. In this mode, the Center Frequency control selects the shelving frequency.
9. **EQ Band Select.** Opens the controls for the selected EQ band.

10. **High Shelf EQ On/Off.** Enabling the High Shelf button turns the High band into a shelving EQ. A high shelving EQ is like a treble-control knob on a stereo. In this mode, the Center Frequency control selects the shelving frequency.
11. **Output Meter (Series III only).** Displays the post-EQ output signal.
12. **Post (Series III only).** Enables the RTA to displays the post-Fat Channel signal.
13. **Pre (Series III only).** Enables the RTA to display the pre-Fat Channel signal.
14. **RTA (Series III only).** Turns on the RTA in the EQ graph.
 

*Note: StudioLive AI-series mixers feature the SMAART RTA and Spectrograph tools. Please see Section 4.1 for more information.*
15. **EQ Type (Series III only).** This drop down menu allows you to select the EQ type for the current channel.

## 3.4 Limiter

To view the controls for the limiter, click on the Limiter tab.

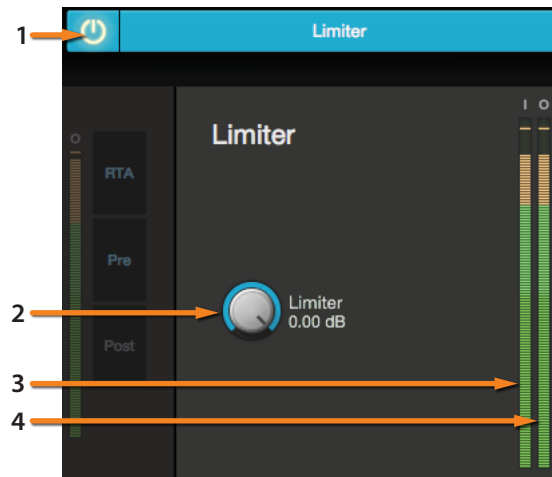

1. **Limiter On/Off.** Turns on the limiter for the selected input channel. The ratio is  $\infty$ :1.
2. **Limiter Threshold.** Sets the threshold of the limiter for the selected channel. When the signal's amplitude (level) exceeds the threshold setting, the limiter is engaged. The threshold can be set from -28 to 0 dB.
3. **Input Meter (Series III only).** Displays the input signal to the limiter.
4. **Output Meter (Series III only).** Displays the outputs signal to the limiter.

## 4 Graphic EQ



To the left of the Fat Channel, you will find the GEQ button. This opens up the graphic EQ for that bus.

- StudioLive Series III mixers provide eight graphic EQs that can be assigned to any output bus.
- StudioLive AI-series RM/RML mixers provide a graphic EQ for the Main bus and the first 14 aux buses.
- StudioLive AI-series console mixers provide a graphic EQ for every aux bus plus the mains.

In general, graphic EQ settings are created prior to a live show and are not adjusted after that. However, minor adjustments sometimes must be made later. UC Surface makes this quick and easy.

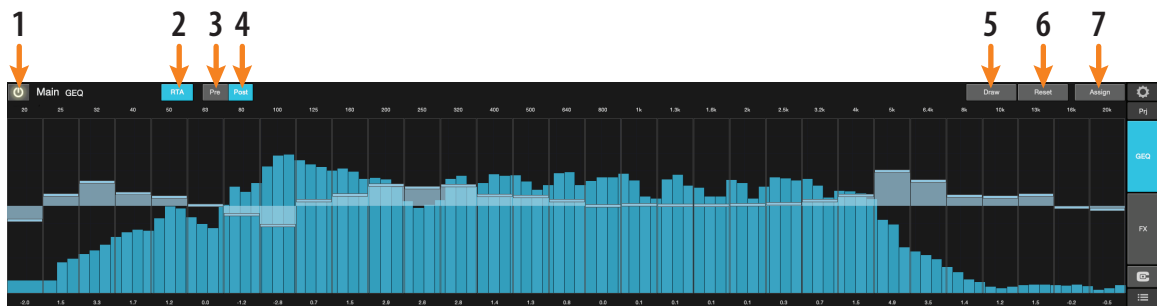

1. **GEQ On/Off.** By default, all graphic EQs are disabled. To enable any GEQ, simply click on this button.
2. **RTA.** Enables RTA view from within the Graphic EQ graph.
3. **Pre (Series III only).** Displays the Pre-GEQ signal in the RTA.
4. **Post (Series III only).** Displays the Post-GEQ signal in the RTA.  
*Note: Smart Spectra Tools are available for StudioLive AI-series mixers from with the Graphic EQ. See Section 4.1 for details.*
5. **Draw GEQ.** Enabling the Draw function will allow you to draw a GEQ curve with your finger or mouse rather than adjusting each band individually.
6. **Reset GEQ.** To zero out all curve settings on any graphic EQ, click on the Reset GEQ button. This will return all band gains to 0 dB.
7. **Assign (Series III only).** Opens the Graphic EQ assign view:

GEQ Assign				Assign	Prj
Main L	Main R	Mono/Center			
Mix 1	Mix 2	Mix 3	Mix 4		
Mix 5	Mix 6	Mix 7	Mix 8		
Mix 9	Mix 10	Mix 11	Mix 12		
Mix 13	Mix 14	Mix 15	Mix 16		
Mix 17	Mix 18	Mix 19	Mix 20		
Mix 21	Mix 22	Mix 23	Mix 24		
Mix 25	Mix 26	Mix 27	Mix 28		
Mix 29	Mix 30	Mix 31	Mix 32		

When the Assign view is open, you can reassign Graphic EQs to different FlexMixes and buses.

## 4.1 Enabling Smaart Analysis (StudioLive AI-series only)

Both the GEQ and Fat Channel EQ provide Smaart Spectra™ analysis when connected to a StudioLive AI-series mixer. Smaart Spectra was developed by Rational Acoustics to power Smaart's Spectrum Measurement Engines and includes an RTA and a spectrograph.

By default, Smaart® analysis is disabled. While Smaart is disabled, you have control over which bus is routed to the second to last pair of auxiliary FireWire inputs.

Clicking on the Spectrograph or RTA buttons will start Smaart, and UC Surface will take control over these FireWire auxiliary inputs.

For more information on the Auxiliary Inputs Router, please see Section 8.3.

*Note: Smaart analysis requires use of the StudioLive AI-series' onboard audio interface. It is not available without a FireWire or FireWire-to-Thunderbolt connection between your mixer and your computer. UC Surface's integrated Smaart modules do not support StudioLive Series III consoles.*

### 4.1.1 Time-Frequency Spectrograph

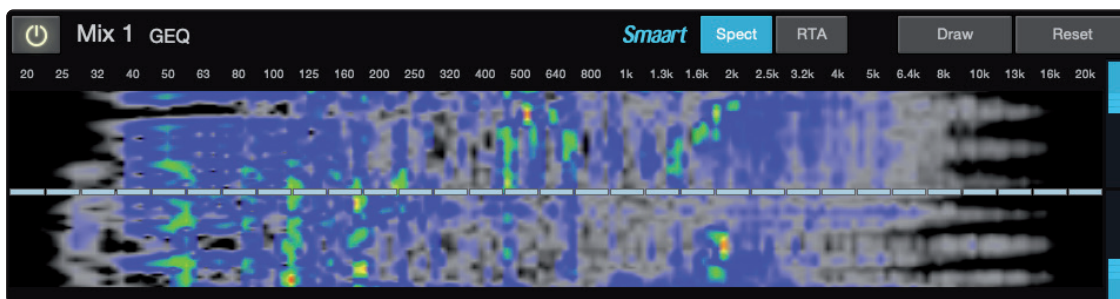

Clicking on the Spectrograph button (from the Fat Channel EQ or GEQ tab) will launch the Time-Frequency Spectrograph. This spectrograph provides a three-dimensional view of your audio in which x = frequency, y = time, and color = decibel level.

Any signal below the lower dynamic-range threshold is black. Any signal above the top dynamic-range threshold is white. Within the dynamic range, colors go from blue to green to red, with blue indicating the quietest and red the loudest.

Many audio signals that are encountered in the field are highly dynamic. Musical signals, speech, and even environmental noise contain significant changes in spectral content as a function of time. The spectrograph can be thought of as a record of multiple RTA measurements taken over time, with color representing amplitude.

Using this function, the spectral content of the input signal is recorded as it changes in time. This allows you to view and analyze time-varying trends in the input signal.

As a troubleshooting tool, the spectrograph is useful for finding spectral “defects” in a system or acoustical environment. Certain audio signals or acoustical events contain specific traits that can be easily detected due to their distinct time/frequency signature—specifically, highly tonal sounds such as AC line noise in an electrical signal chain or the presence of electro-acoustical feedback.

#### Dynamic Range

UC Surface provides dynamic-range sliders that set the maximum and minimum volume thresholds for the spectrograph.



### 4.1.2 RTA

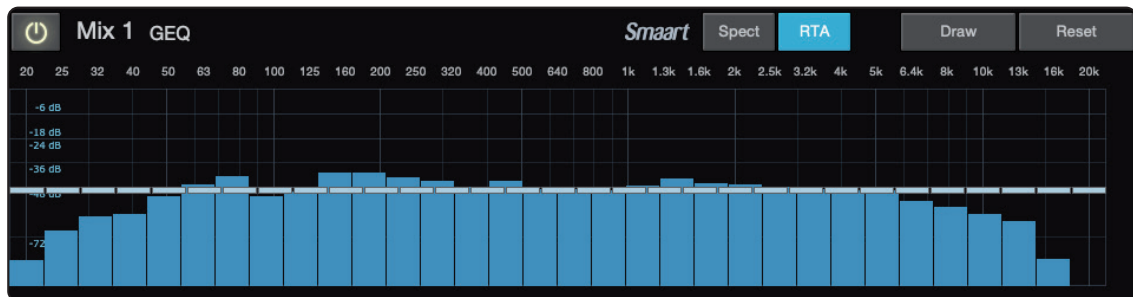

Clicking on the RTA button (from the Fat Channel EQ or GEQ tab) will launch a real-time analyzer in which  $x$  = frequency and  $y$  = amplitude. An RTA provides a close visual representation of what you are hearing. It provides a view of the long-term spectrum of the signal, such as the one-third-octave spectrum long-term average of a musical performance.

## 4.2 Using the Smart Spectrograph to Ring Out Monitors

The spectrograph shows frequency data over time, so a constant frequency, such as feedback, results in a straight line in the spectrograph. In a feedback loop, a portion of the signal from the speaker returns to the microphone, resulting in a buildup of energy that creates squealing, screeching feedback. “Ringing out” is a process of attenuating the frequencies that are feeding back to maximize gain before feedback in your floor monitors.

1. With the mic input gain at an appropriate level, bring the aux-send level up on the mic channel you wish to ring out.

**Power User Tip:** If you are using one console for stage monitors and another console for front-of-house, set the mic input gain on the front-of-house console. Do not “gain up” the mic signal on the monitor mixer for the sake of getting more volume out of a stage monitor, as you can do that in other places (Mix level for individual channels, Aux Out level for global control, etc.). Gain staging is very important in order to have a feedback-free show.

2. Select the graphic EQ for the aux output of the stage monitor you are ringing out
3. Enable the spectrograph.
4. Slowly bring the aux output level up until you hear (and see) feedback.

**Note:** Ringing out stage monitors will produce feedback. If you are not careful, you can produce a lot of feedback. Do not make sudden gain boosts; go slowly and carefully to avoid causing any damage to speakers and ears.

5. Feedback will show up as a solid line on the spectrograph and as a line peak on the RTA. Use the dynamic threshold to adjust how bright, and at what input level, the frequency information plots.
6. Lower the GEQ fader for the offending frequency in 3 dB increments to attenuate it out of your stage monitor.

**Power User Tip:** Bring back the level on the GEQ slider to the point just before feedback so you don't take out too much frequency content and sacrifice overall timbre. Because the speaker is pointed at the mic, stage-monitor feedback typically occurs in the higher frequencies, which also is where intelligibility comes from. Maximizing your intelligibility and gain structure results in clearer-sounding monitors.

You can apply this process to the main system, as well. This is especially useful with applications requiring lavalier or podium mics. These types of microphones are typically omnidirectional condensers and are very prone to feedback.

In a main system, feedback is typically in the mid to low range. The frequencies that are regenerating and creating a feedback loop are those frequencies that are wrapping around the main system due to the loss of directional control of lower frequencies.

When you are ringing out a system, and more than two or three feedback loops are happening simultaneously, you have reached the level where stability can no longer be achieved. Try bringing down the overall output level or find a physical solution, such as moving the speaker or microphone.

### 4.3 Using the RTA While Mixing

The RTA provides a view of amplitude and frequency content over a specified plane. The ability to analyze frequency content—specifically, being able to visualize the exact frequencies you are hearing in order to hone in on problem areas— makes it a secret weapon for many mix engineers.

Because the RTA is analyzing the channel or bus signal digitally, room and speaker anomalies are taken out of the equation. This provides a pure measurement of your mix, because you are measuring what is happening inside your StudioLive.

**Power User Tip:** *The RTA can be useful in understanding what the frequency content of an instrument when creating space for it in a mix. For example, let's say you are mixing a particularly edgy-sounding lead guitar that is competing with the male vocal and distracting from the overall good tone of the instrument. By using the RTA in the Fat Channel, you can quickly identify the offending frequency by looking for spikes in the RTA. This saves time and frustration by taking some of the guesswork out of equalization. It should be noted, however, that an RTA cannot be used as a substitute for careful listening. While this tool provides a great visual analysis of your mix, critical listening must always be your main guide.*

## 5 Adding Effects

Your StudioLive mixer is equipped with multiple FLEX FX internal effects processors each with a dedicated mix bus.

- StudioLive Series III 32-channel mixers have four freely assignable processors.
- StudioLive 64S mixers are equipped with eight freely assignable processors.
- StudioLive AI-series mixers have two processors dedicated for reverb effects and two more dedicated for delay effects.

Regardless of model, the effects returns for any effect bus can be routed to any mix bus.



Creating an effects mix is just like creating a monitor mix: Simply click on the effects mix and select and set the level for each channel to which you would like to apply reverb or delay.

Effects returns for each processor are available at the end of the input channels in each mix.

### 5.1 Editing Effects



To access the effects library for each processor and make adjustments to effects parameters, click on the FX View button on the left side of the Fat Channel.

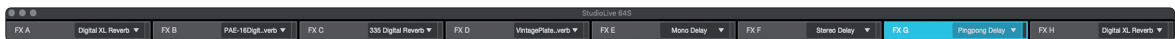

Across the top of the window, you see each of the effects buses and the current selected effects type for each bus. To edit an effect, simply click on its bus.



This will open the effects editor. From here, you can change the effects type, adjust parameters, and load presets.



12. **Audition.** When the Audition button is engaged, each preset will nondestructively load into your channel, using the currently enabled filters. This lets you try out a preset before loading it and overwriting the current settings. You can make changes to this preset in real time. To load the settings you've auditioned, click the Load button.
13. **Reset.** Restores the Fat Channel to its default settings. The Preset Load filters can be used to configure which settings will be reset.

## 6.2 GEQ Presets



While the GEQ View button is active, the Preset button launches the GEQ Presets menu. To close the menu and reopen the mixer view, simply click the button again.

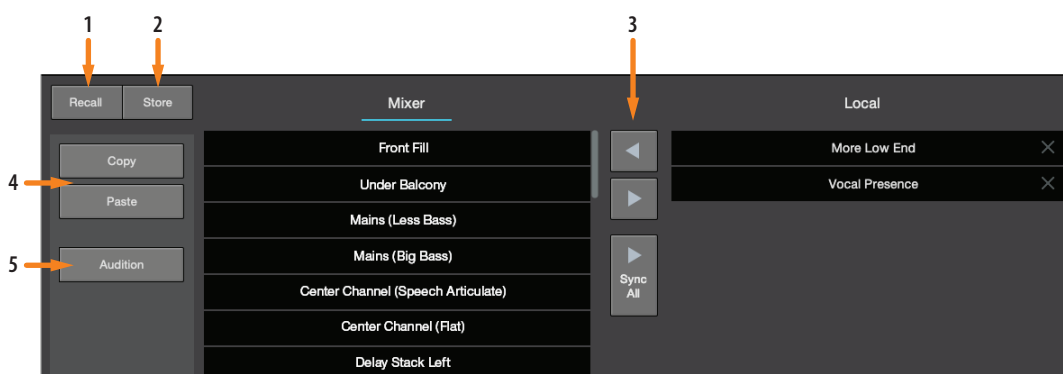

1. **Recall.** Loads the current preset to the selected bus.
2. **Store.** Creates a GEQ preset from the currently selected bus GEQ's settings.
3. **Preset Manager.** Displays presets that are stored locally on the device running UC Surface and presets stored locally on the mixer. *See Section 6.5 for more information.*
4. **Copy/Paste.** To copy the effects settings to another bus's GEQ, simply click on Copy; from the GEQ Bus Select menu, select the bus to which you'd like to load the settings; and click Paste.
5. **Audition.** When the Audition button is engaged, each preset will nondestructively load into the currently selected effects bus. This lets you try out a preset before loading it and overwriting the current settings. You can make changes to this preset in real time. To load the preset you've auditioned, click the Load button.

## 6.3 FX Presets



While the FX View button is active, the Preset button launches the FX Presets menu. To close the menu and reopen the mixer view, simply click the button again.

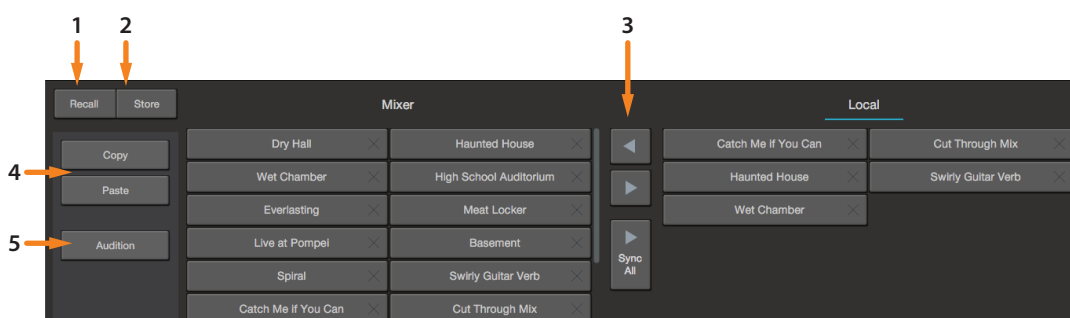

1. **Recall.** Loads the current preset to the selected channel.
2. **Store.** Creates an effects preset from the currently selected effects bus settings.
3. **Preset Manager.** Displays presets that are stored locally on the device running UC Surface and presets stored locally on the mixer. *See Section 6.5 for more information.*
4. **Copy/Paste.** To copy the effects settings to another effects bus, simply click on Copy; from the banner at the top of the window, select the bus to which you'd like to load the settings; and click Paste.
5. **Audition.** When the Audition button is engaged, each preset will nondestructively load into the currently selected effects bus. This lets you try out a preset before loading it and overwriting the current settings. You can make changes to this preset in real time. To load the settings, you've auditioned, click the Load button.

## 6.4 Preset Management

Presets can be stored locally on your StudioLive mixer or locally on your computer and copied between the two.

### Syncing the Mixer Library

Presets stored in the mixer library can be copied to the device running UC Surface either individually or you can sync the entire preset library.



To sync every preset, click or touch the Sync all button.

You can copy individual presets to and from your mixer's memory by simply dragging dropping them between the Mixer and Local sections of the Library Management area.

**Note:** *Dragging and dropping a preset allows you to overwrite currently used library slots, so be careful where you drop it!*



You can also use the Transfer buttons to transfer one preset to and from the Mixer and Local libraries. When transferring to the Mixer library, the preset will be moved to the first available Empty Location.



## 7 Projects and Scenes

Every parameter on your StudioLive mixer can be stored and recalled later. Global settings, like FlexMix modes, Talkback assignments, and all the routing set in the Digital Patching menu in addition to System settings like Sample Rate, Network Settings, and Cue Source are stored within **Projects**.

Because fundamental routing and bus structure is being changed when a Project is recalled, the load time for Projects is slightly longer than loading a Scene or Preset. It is recommended that Projects are not loaded during a performance or other live application.

All other mixer settings like Channel Strip parameters, Fat Channel models and settings, and Channel Identifiers like name, color, and type are stored inside of **Scenes**.

Scenes that share the same Global System settings should be stored within the same Project. Many Scenes can be stored within each Project but scenes created in one Project cannot be recalled in any other Project.

*Note: Only StudioLive Series III mixers v. 2.0 firmware and higher offer this functionality. StudioLive AI-series mixers employ a traditional Scene. See Section 7.2 for more information.*

### 7.1 Project and Scene Management (StudioLive Series III)



To access your Project and Scene Libraries, press the 'Prj' button.

The controls on the left side of the screen save and load Projects as well as resets the default routing of your mixer. The controls on the right side on the screen save and load Scenes within the current Project, as well as resets the default state of every currently recallable parameter.

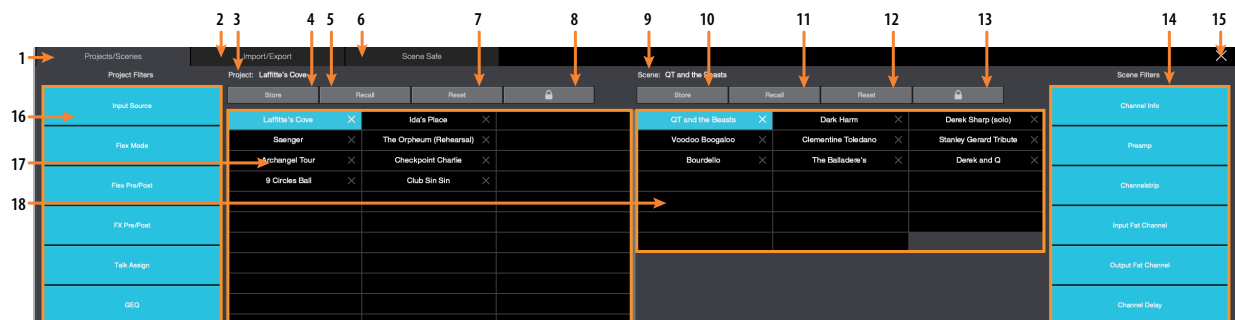

1. **Project / Scene Manager Tab.** Click / Tap to view, store, and load Projects and Scenes on your mixer's local memory.
2. **Import/Export Tab.** Click / Tap to transfer Project and Scenes between you mixer memory and the device running this instance of UC Surface.
3. **Currently Loaded Project.** Displays the name of the Project file that is currently loaded on your StudioLive mixer.
4. **Store Project.** Click / Tap to store your current global settings as a new Project or to update an existing Project file.
5. **Recall Project.** Click / Tap to load the currently highlighted Project file. *Note that because Projects are altering parameters of global functions, they take slightly longer to load. Because of this PreSonus recommends loading Projects prior before mixing a session live.*
6. **Scene Safe Tab.** Click / Tap to select channels that will not be effected by a Scene recall.
7. **Reset to Default.** Click / Tap to reset all global parameters to their factory default. This includes all digital patching and FlexMix modes.

8. **Lock Project.** Click / Tap to lock the currently selected Project library slot. This will prevent the file from being overwritten. When this is enabled, no new data can be stored to this location until it is unlocked.
9. **Currently Loaded Scene.** Displays the name of the Scene file that is currently loaded on your StudioLive mixer.
10. **Store Scene.** Click / Tap to store your current mix settings as a new Scene within the current Project or to update an existing Scene file.
11. **Recall Scene.** Click / Tap to load the currently highlighted Scene file.
12. **Reset to Default.** Click / Tap to reset all mix parameters to their factory default. This will **not** reset Global parameters like digital patching and FlexMix modes.
13. **Lock Scene.** Click / Tap to lock the currently selected Scene library slot. This will prevent the file from being overwritten. When this is enabled, no new data can be stored to this location until it is unlocked.
14. **Scene Filters.** When recalling a Scene, you can choose to omit certain sets of parameters. When a filter is blue, the parameter set will be recalled. When grey, the parameter set will be omitted from the recall and these settings will remain unchanged.
15. **Close Project/Scene Menu.** Click / Tap to the 'X' to exit and return to the mix view in UC Surface.
16. **Project Filters.** When recalling a Project, you can choose to omit certain sets of parameters. When a filter is blue, the parameter set will be recalled. When grey, the parameter set will be omitted from the recall and these settings will remain unchanged.
17. **Project Library.** Every Project stored locally on your StudioLive mixer will be displayed here.
18. **Scene Library.** Every Scene stored within the currently loaded Project will be displayed here.

### 7.1.1 Import /Export

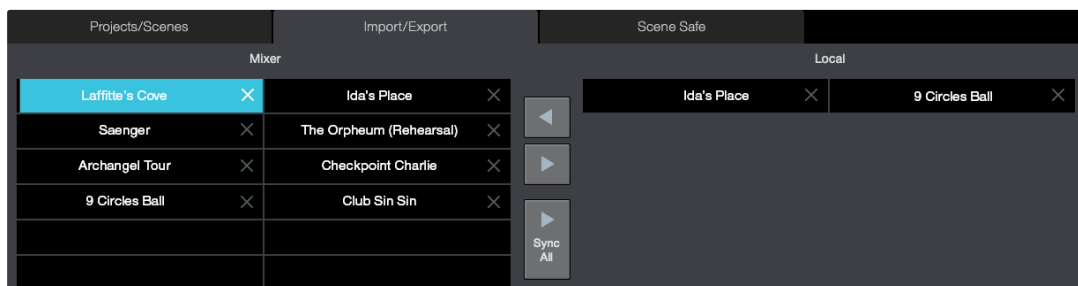

Projects can be stored locally on your StudioLive mixer or locally on your computer and copied between the two.

#### Syncing the Mixer Library

Projects stored in the mixer library can be copied to the device running UC Surface either individually or you can sync the entire preset library.



To sync every Project, click or touch the Sync all button.

You can copy individual Projects to and from your mixer's memory by simply dragging dropping them between the Mixer and Local sections of the Library Management area.

**Note:** When a Project is transferred, so are all the Scenes stored within it.



You can also use the Transfer buttons to transfer one preset to and from the Mixer and Local libraries. When transferring to the Mixer library, the preset will be moved to the first available Empty Location.

## 7.2 Mix Scenes (StudioLive AI-series)



UC Surface allows you to create and store a library of scenes. A scene is like a snapshot of your mix: It stores each Fat Channel parameter for every analog input, as well as each fader's position, the aux and effects mixes, channel mutes and solos, etc.

### 7.2.1 Quick Scenes

The Quick Scene buttons in the Scene view allow you to create a scene without storing it to the Scene Library, either on your mixer's memory or in UC Surface on your computer or mobile device and giving it a name. This is especially useful when mixing multiple bands that you might not ever mix again. Quick Scenes are stored in non-volatile memory and will be retained when your mixer is power cycled.

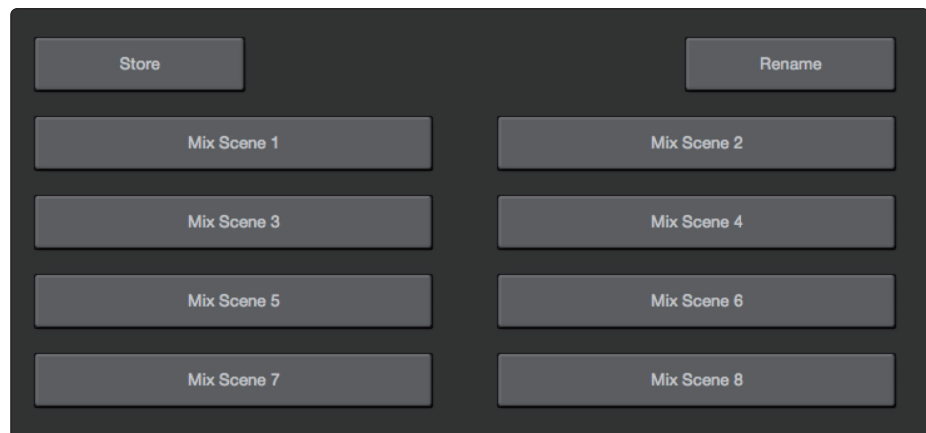

UC Surface provide the following Quick Scene controls:

**Store.** To create a Quick Scene, click or tap the Store button. All the Quick Scene buttons will flash. Click on the Quick Scene to which you'd like to store the current mixer settings.

**Quick Scenes 1-8.** Loads the stored Quick Scene. This will override all the current settings on the mixer based on the Scene filters (discussed shortly).

### 7.2.2 Scenes Library



To store a scene in permanent memory, either on your mixer or locally on your computer, press the Preset button while the Scene view is active. This will open your Scene library. Press the button again to close it.

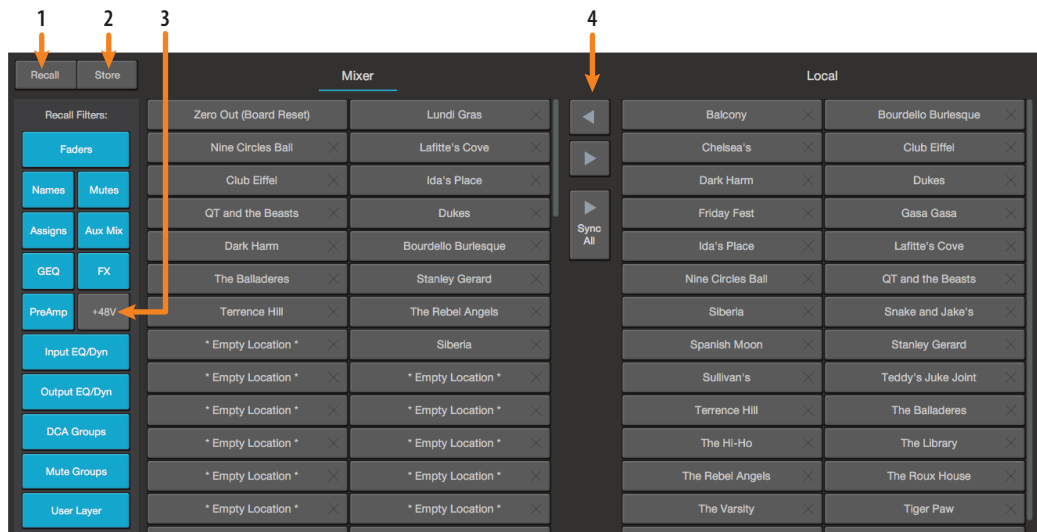

1. **Recall.** Click on this button to load the currently selected scene.
2. **Store.** Click on this button to create a new scene from the current mixer settings.
3. **Scene filters.** UC Surface mix scenes store the settings of the entire mixer. You can choose to load the entire scene or filter various portions of it.
4. **Scene Manager.** Displays scenes that are stored locally on the device running UC Surface and scenes stored locally on the mixer. *See Section 6.5 for more information.*

### 7.2.3 Scene Safe Edit

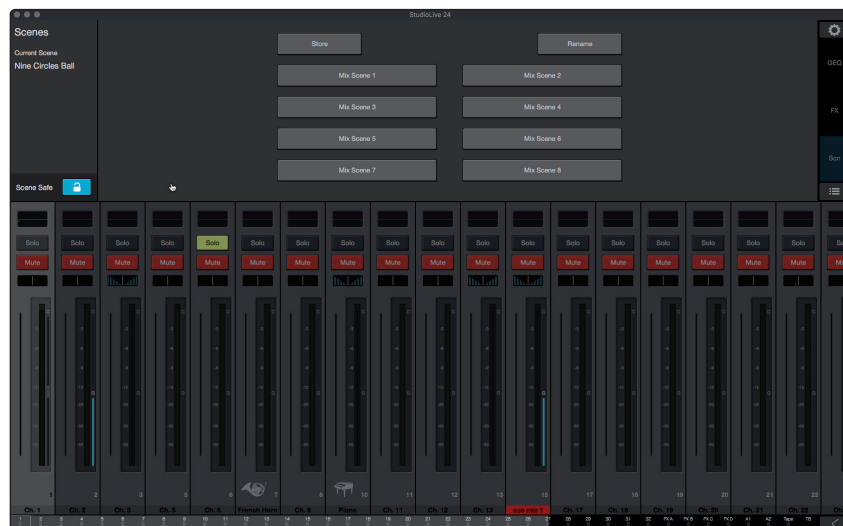

Engaging the Scene Safe Edit button allows you to disable recalling any scene parameters on specified channels.

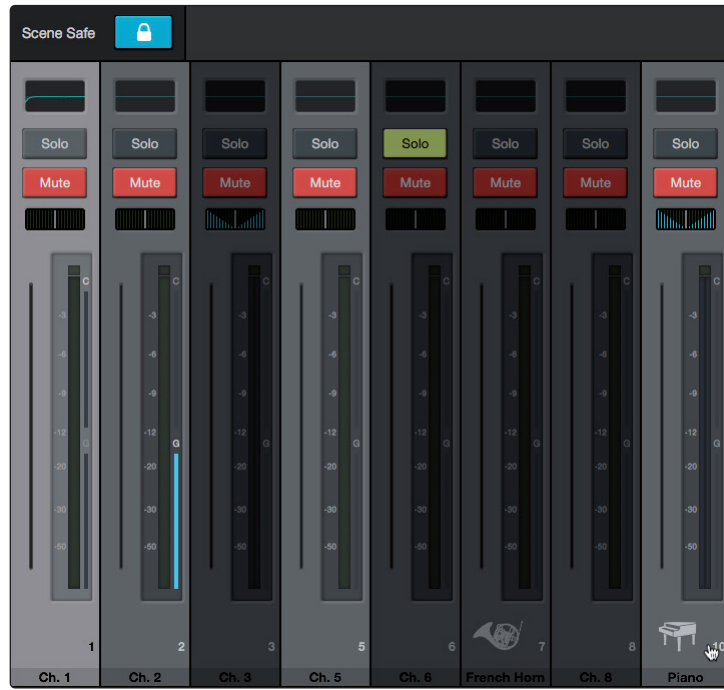

To enable Scene Safe mode on any channel, simply click on it while Scene Safe Edit is engaged. Once selected, a channel will always be omitted while recalling any mix scene.

## 8 Quick Panel Functions

The Quick Panel provides easy access to the following functions: Talkback, Mute Groups, Fader Locate (StudioLive AI-series console mixers), FX Bus mutes, and Tap Tempo.



To open or close the Quick Panel, click on the arrow in the lower right hand corner of the screen.

### 8.1 Talkback

The Talkback feature lets you communicate with the performers and audience. The talkback level is individually controllable from each mix. You will find the level control after the input and playback channels.



Click on the Talkback button to enable the Talk function on your StudioLive mixer.

#### 8.1.1 Talkback Destination

To select the destination for your Talkback routing, click or tap the Talk Assign button, then click or tap on the mix to select it. For StudioLive AI-series console mixers, the mixes will be arranged in the same groups as the physical buttons on your mixer.



The Select buttons for the mixes to which the Talkback has been routed will turn red to indicate that Talkback is active.

### 8.1.2 Talkback Source (StudioLive Rack Mixers)

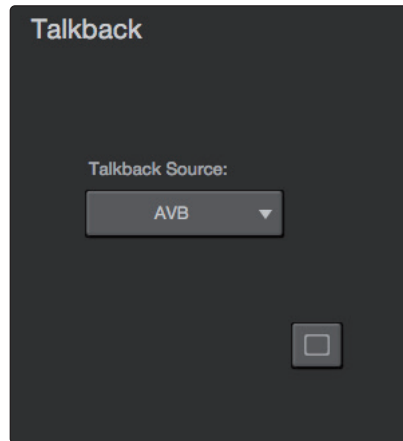

Any channel on your StudioLive rack mixer can be designated as the talkback source. To select a talkback source, select the talkback channel in any mix.

You will be able to select the input you'd like to use, control the preamp level, and enable phantom power. If your mixer is connected via AVB to a StudioLive console mixer, you can also choose the console mixer's dedicated talkback input by selecting "AVB" from this menu.

### 8.2 Mute Groups

A mute group allows you to mute and unmute multiple channels and buses with the press of a single button. With the eight mute groups in UC Surface, you could, for example, assign the drum mics to Mute Group 1, the instrumentalists to Mute Group 2, the background vocalists to Mute Group 3, all the aux buses to Mute Group 4, all four FX buses to Mute Group 5, and every channel on the mixer to Mute Group 6, and so on. In this way, you can quickly mute multiple channels at once.

Click on the Mute button in the Quick Panel to view the mute groups.

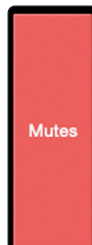

UC Surface provides the following mute group controls:

**All On.** Mutes all channels and buses. The All On Group is a preconfigured mute group that includes every channel and bus with a Mute button.

**All Off.** Clears all mutes. When the All Off Button is pressed, any channel or bus that has been muted will be unmuted.



**Mute Group 1-8.** Engages/disengages assigned mute groups. When any of the Mute Group buttons is pressed, the assigned group of channels or buses will be muted/unmuted.

**Save.** To create a mute group, click or tap the Save button. All the Mute Group buttons will flash. Click on the mute group to which you'd like to store the current mute settings.

**Power User Tip:** Both the mute groups and All On only add mutes to your mix and remove the same mutes they added. Mute groups will not clear mutes that were active prior to the mute group being engaged. (i.e., if a mute is engaged when its mute group or All On are enabled, it will still be engaged when you disable the mute group or All On.) The exception to this rule is the All Off button. This button will clear any mute that is currently enabled and will deactivate any mute group that is active, including All On.

### 8.3 FX Mutes



You can mute your FX buses one of two ways: Globally or Individually. To mute every FX bus simultaneously, click or tap on the Mute All FX button.



To mute FX buses individually, click or tap on the FX Mutes button. This will display individual mutes for each bus.

### 8.4 Fader Locate (StudioLive AI-series Console Mixers only)

StudioLive AI-series console mixers are not equipped with motorized faders. So when you remote control your mixer from UC Surface, the main mix you see in UC Surface and hear in your front-of-house speakers will not match the mix you see on the physical faders.



The Fader Locate button provides a visual representation of where your physical faders are, relative to the virtual faders in UC Surface. Moving a fader on your StudioLive AI-series console mixer will not affect the mix until it intersects with the current position of the virtual fader.

## 9 The Settings Page

The Settings page allows you to customize your StudioLive mixer and UC Surface, allowing you to create a flexible mix system for your application. From the settings page you can:

- Customize the look and feel of UC Surface
- Configure your control network settings
- Connect to EarMix 16M Personal Monitor Mixers and NSB-series Stage Boxes
- Route audio to and from the AVB Network
- Patch any input or bus to any channel or output
- Create User Profiles and customize device permissions
- Authorize additional Fat Channel plug-ins
- Back up your entire mixer

StudioLive AI-series mixers will find network customization and device permission options as well as access to FireWire Aux Inputs routing and the Smart Wizards.



To open the Configuration Settings page, click on the Settings button in the upper right hand corner of UC Surface.

### 9.1 Device Settings

The Device Settings tab allows you to customize your StudioLive experience in UC Surface and manage your remote mobile devices.

#### 9.1.1 Device Permissions

Controlling your StudioLive remotely with UC Surface or QMix-UC for mobile devices allows you to move about the venue freely. However, it can also put the full power of the StudioLive in multiple hands— some more adept than others. Therefore, your StudioLive enables you to limit each wireless device's access to the mixer features by setting permissions.

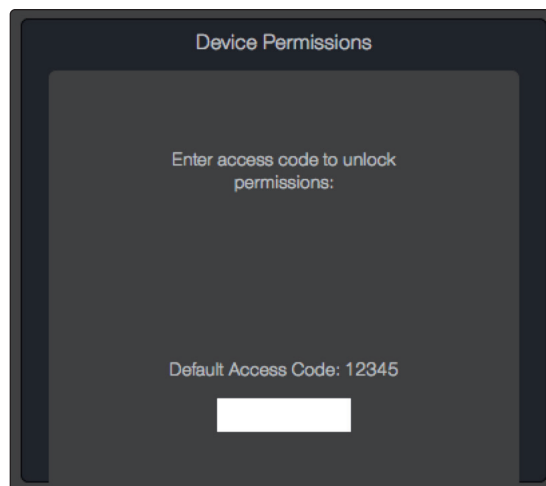

Once a device is connected to your wireless network and has launched UC Surface or QMix-UC, the device will be displayed in the Device Permissions list. Each device will be listed using its device name so you can easily identify which device is which.

Once you have connected and configured a device, the same permissions will be set for that device every time you connect it. Complete information about QMix-UC can be found in the *QMix-UC Reference Manual*.

### UC Surface Permissions

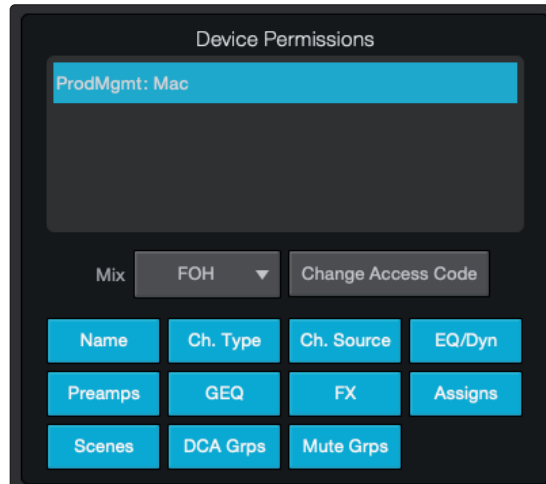

When setting permissions for UC Surface users, you will choose between giving full access to all mix functions or providing limited access to just a few aux-mix functions. In most cases, one device will be configured as front-of-house (FOH), and the others will be configured as aux mixes.

- **None.** The selected device will not be able to control your StudioLive mixer.
- **FOH.** Enables all UC Surface functions for the selected device.
- **All Auxes.** The selected device will only control the channel send levels for all aux mixes.
- **Aux 1...** UC Surface will only control the channel send levels for the specified aux mix.

StudioLive Series III mixers provide an added permissions layer that allows you to make different functions available or inaccessible per device.

- **Other Permissions.** Use these buttons to enable access the stated set of parameters regardless of the Mix Permission mode you have selected for this device. This allows you further customize the level of control you grant to each user.

*Note: This features is only available on StudioLive Series III mixers.*

### QMix-UC Permissions

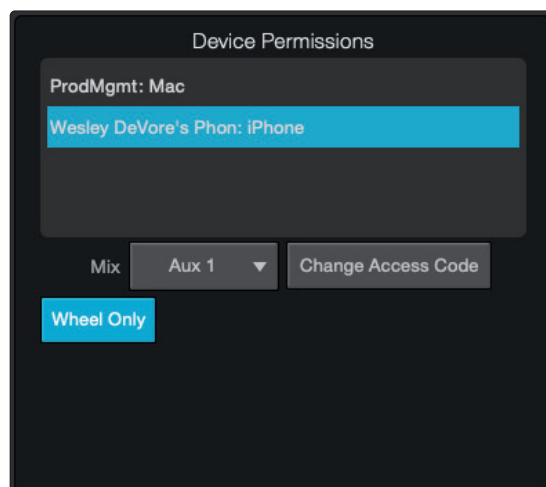

When setting permissions for QMix-UC users, you will choose between providing full access to all aux mixes and providing access to only a single aux mix.

- **None.** The selected device will not be able to control your StudioLive mixer.
- **All Auxes.** QMix-UC will control the channel send levels for all aux mixes.

- **Aux 1...** QMix-UC will only control the channel send levels for the specified aux mix.

When a user has access to a single aux mix, you also have the option to limit control to the Wheel of Me only. Wheel Only disables the Aux Mix page in QMix-UC. When this is enabled, the user will only be able to use the Wheel of Me on the aux to which you've provided access.

### Change Access Code

This button allows you to set a custom access code for each UC Surface device so that once permissions have been set, they cannot be changed locally on the device without the correct access code. By default, the access code is 12345.

#### 9.1.1.1 Setting Permission on StudioLive AI-Series Consoles

Permissions for UC Surface can also be set from your StudioLive AI-series console mixer. Once a tablet is connected to your wireless network and has launched UC Surface, the device will be displayed in the Remote Devices list on the System Menu on your StudioLive. Each device will be listed using its device name so you can easily identify which device is which.

1. Press the System button on your StudioLive to launch the System menu and Page down to navigate to Page 3: iOS Setup.



2. Use the Value encoder to scroll through the list of available iOS devices.

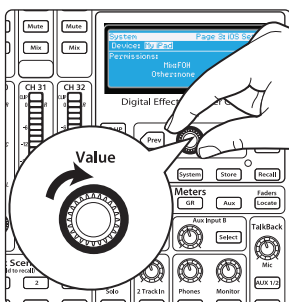

3. When you find the device for which you'd like set permissions, use the Next button to navigate to the first permissions field. Use the Value encoder to set the device permission.

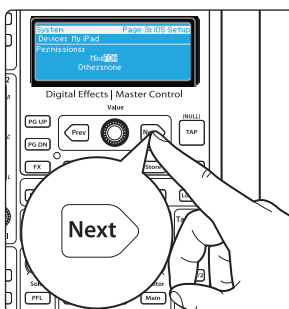

### 9.1.2 Configure Lockout (StudioLive AI Console Mixers)

You can lock out the functions of your StudioLive AI-series mixer when you are away from it by creating a password.

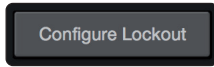

1. To do this, you must click on the Configure Lockout button from the Settings page.
2. Enter the 5-digit numeric passcode you would like to use.
3. To make the mixer able to be locked, enable Device is Lockable.
4. Click Set Lockout save the passcode.

#### Locking Your Mixer

Once the passcode has been set, you can lock or unlock your mixer any time by navigating to Page 8 of the System menu on your mixer.

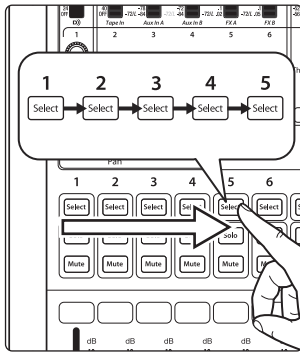

Press the Select buttons that correspond to the 5-digit code you saved. For example, if you set the passcode as 1-2-3-4-5, you would press the Select buttons for Channels 1-5 respectively.

### 9.1.3 Firmware

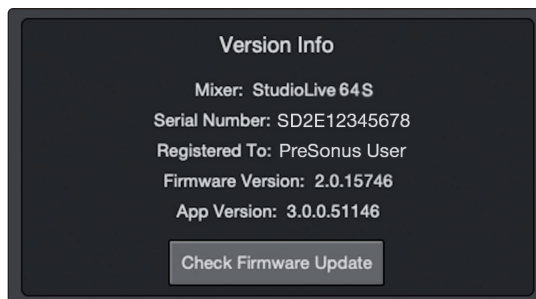

UC Surface allows you to view the currently installed firmware version on your StudioLive mixer as well as the version of UC Surface you are running.

When connected both the Internet and to a StudioLive mixer, UC Surface can check for the latest firmware version and update your mixer's firmware by clicking on the Check Firmware Update button.

### 9.1.4 System Settings

The System Settings area allows you to customize your StudioLive mixer. The functions displayed on this page will vary depending on what type of StudioLive mixer you have connect to UC Surface. This section will describe the functions available for each mixer type.

#### 9.1.4.1 StudioLive Series III Mixers

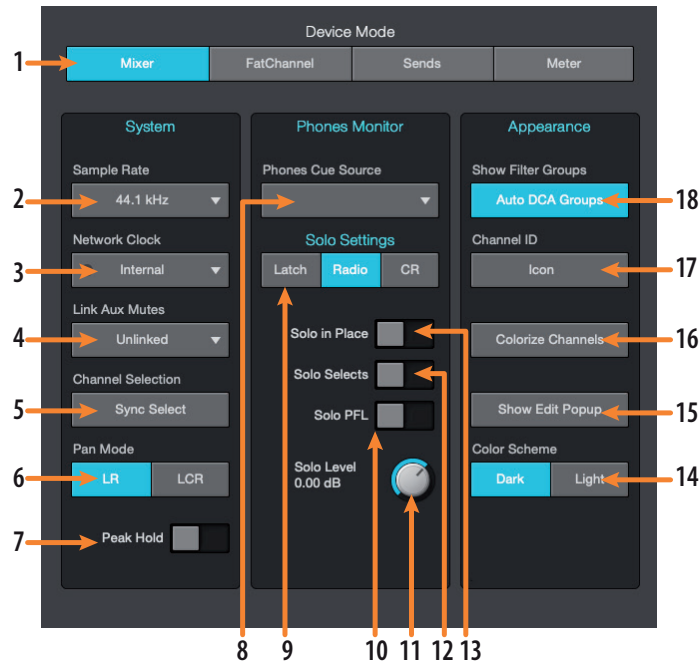

1. **Device Display Mode.** Selects the viewing mode for UC Surface:
  - **Mixer.** While in Mixer Display mode, you have access to every function, making it great for remote mixing.
  - **Fat Channel.** Fat Channel Display mode is designed to function as a second screen for your mixer. In this display mode, all the Fat Channel features for each channel will be displayed rather than every function on the mixer. You can select a different channel to view either from your mixer or from the meter bridge in UC Surface.
  - **Sends.** Aux Sends mode provides two display options. While on inputs, UC Surface will display all the bus sends for the selected channel. While on outputs, UC Surface will display all the channels for a selected bus as well as the bus master. Use the meter bridge to select a different channel or bus.
  - **Meter.** Meter mode displays all the channel meters and mutes for every input channel and output bus.
2. **Sample Rate.** Sets the Sample Rate for your mixer.
3. **Network Clock.** Sets the clocksource for networked mixers. When using two or more mixers with stand-alone functionality on the same AVB network, only one can be set to Internal clock. The other mixers must be set to "Network Stream." By default, StudioLive Series III rack mixers in Stage Box Mode default to stream. For more information, please review the *PreSonus AVB Networking Guide*.

4. **Link Aux Mutes.** Sets the operation mode for linking mute buttons between channels and aux sends.
  - **Unlinked.** When this mode is selected, channel mutes can be independently controlled in each Aux Mix and the Main Mix.
  - **Main Mute Auxes.** When this mode is selected, muting a channel in the main mix will mute it in every aux mix. However, channels can be muted and unmuted independently from each aux mix.
  - **All Aux Mute Link.** When this mode is select, the channel mutes for every aux mix are linked. In this mode, muting a channel from any aux mix will mute it in every aux mix but not in the Main mix.
  - **Global Mute Link.** When this mode is select, the channel mutes for every aux mix and the Main mix are linked. In this mode, muting a channel from any mix will mute it in every mix.
5. **Peak Hold.** Sets the type of metering. StudioLive mixers offer both Peak and Peak Hold metering. To view the Peak Hold, simply enable this preference.
6. **Sync Select.** In situations where you are using UC Surface as a second (or third) screen for your StudioLive mixer, you may wish to keep UC Surface and your mixer focused on the same channel or bus. Enabling Sync Select will let you select a channel or bus on either your mixer or on your UC Surface device.
7. **Pan Mode (StudioLive 64S only).** The StudioLive 64S features an independent Mono/Center bus that can be configured either as a mono bus or as the center channel in an LCR system. For more information, *please review the StudioLive Series III Owners Manual.*
8. **Phones Source.** Selects the Cue Source for the headphone outputs.
9. **Solo Mode (Defaults to Radio mode).** These buttons let you choose from the following behavioral modes for channel soloing:
  - **Latch.** In this mode, you can solo multiple channels or buses at once.
  - **Radio.** In this mode, only one channel or bus can be soloed at a time. When this mode is chosen, the Select Follows Solo button appears. Enabling this option causes channels and buses to be selected for Fat Channel editing when soloed (as though the corresponding Select button had been pressed).
  - **CR (Control Room).** In this mode, soloed signals are sent directly to the monitor output bus, temporarily disabling any other signals that are routed to that output. When solo is disengaged, any existing routings to the monitor outs are re-enabled.
10. **Solo PFL On/Off.** Enables Pre-Fader Listen (PFL) Soloing. The default setting for the Solo bus is After-Fader Listen (AFL); by pressing PFL, Pre-Fader Listening is enabled. In either mode, pressing Solo on any channel or bus routes that channel to the Solo bus and has no effect on the main or subgroup mixes. - PFL soloing is not available for the subgroups. - Aux bus soloing is always PFL, regardless of whether this mode is engaged.
11. **Solo Level.** Controls the output level of the Solo bus.
12. **Solo Selects.** When Radio Solo mode is enabled, the Solo Select option will be available. When Solo Select is active, soloing a channel will also select it. This is available for all three solo modes.
13. **Solo In Place On/Off Button.** Enables Solo In Place. SIP (Solo In Place), or “destructive soloing,” mutes every unsoloed channel on the StudioLive. If one of the muted channels is routed to the mains or a subgroup, it will be muted in those outputs. This also applies to soloed channels: The output routing is still active. Note that while you can manually unmute a channel, this mode should be used with extreme caution during a live performance. Only the input channels can be placed in destructive soloing. The subgroups and aux buses are omitted from SIP mode.



**Power User Tip:** When SIP is engaged, channel mutes will only apply to the subgroup and main bus assignments. SIP does not mute input channels in aux-bus mixes. Because of this, you can use SIP to dial in a mix in the mains without disturbing the musicians' last-minute rehearsal on stage. Destructive soloing is also a great way to tune each channel's dynamics individually in live-mixing situations or do surgical editing in the studio. SIP mode mutes every channel and bus that is not soloed in the Main bus (that is, if Channel 3 is soloed, you will only hear Channel 3 in your mains). This makes a great fine-tuning tool but it can quickly destroy a live mix. We highly recommend that you drop out of this mode once the show has started.

14. **Color Scheme.** These two luminosity presets compensate for environmental light interference.
15. **Show Edit Popup.** Presents a large display of parameter value for each function.
16. **Colorize Channels.** Custom colors shade the entire channel strip, rather than just the channel label.
17. **Channel ID.** Choose between Icon only or Icon with channel number.
18. **Show Filter Groups.** This option allows to show or hide the filter groups that are created automatically when channels are categorized.

### 9.1.4.2 StudioLive AI-series RM/RML mixers

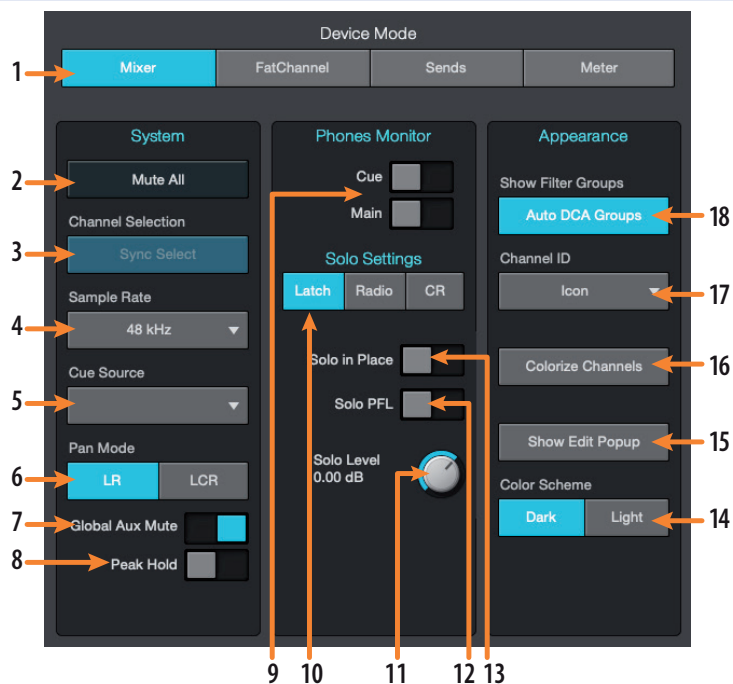

1. **Device Display Mode.** Selects the viewing mode for UC Surface:
  - **Mixer.** While in Mixer Display mode, you have access to every function, making it great for remote mixing.
  - **Fat Channel.** Fat Channel Display mode is designed to function as a second screen for your mixer. In this display mode, all the Fat Channel features for each channel will be displayed rather than every function on the mixer. You can select a different channel to view either from your mixer or from the meter bridge in UC Surface.
  - **Sends.** Aux Sends mode provides two display options. While on inputs, UC Surface will display all the bus sends for the selected channel. While on outputs, UC Surface will display all the channels for a selected bus as well as the bus master. Use the meter bridge to select a different channel or bus.
  - **Meter.** Meter mode displays all the channel meters and mutes for every input channel and output bus.

2. **Mute All.** Mutes every input and output.
3. **Sync Select.** Syncs channel selection between the mixer and across all devices running UC Surface.
4. **Sample Rate.** Sets the sample rate for your mixer.
5. **Cue Source.** Sets the audio source for the cue mix.
6. **Pan Mode.** Sets the main bus output type as stereo L/R or as LCR (Left-Center-Right).
7. **Global Aux Mute.** Controls channel mutes per mix. Setting Global Aux Mute to “No” will allow you to mute your channels per mix on RM-series mixers.
8. **Peak Hold.** Sets the type of metering. StudioLive mixers offer both Peak and Peak Hold metering. To view the Peak Hold, simply enable this preference.
9. **Phones Monitor.** Sets source for the headphone output.
10. **Solo Mode.** Sets the solo behavior:
  - **Latch.** Multiple channels and buses can be soloed at the same time.
  - **Radio.** Only one channel or bus can be soloed at a time.
  - **CR.** Soloing any channel will patch the Solo bus to the Monitor bus.
11. **Solo Level Control.** Adjusts the overall level of the solo bus.
12. **Solo PFL.** Enables/disables PFL soloing.
13. **Solo in Place.** Enables/disables destructive solo.
14. **Color Scheme.** Luminosity presets to compensate for environmental light interference.
15. **Show Edit Popup.** Presents a large display of parameter value for each function.
16. **Colorize Channels.** Custom colors shade the entire channel, rather than just the channel label.
17. **Channel ID.** Choose between Icon only or Icon with channel number.
18. **Show/Hide Auto Groups.** Shows/hides Auto Filter DCAs. When categories are applied, UC Surface automatically creates a Filter DCA group based on each category. To hide these groups, simply turn off this preference.

### 9.1.4.3 StudioLive AI-Series console mixers

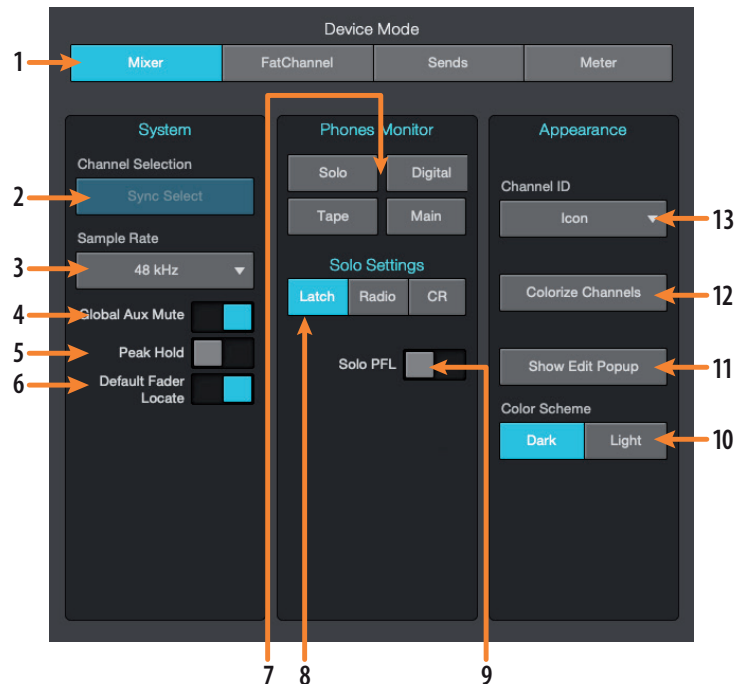

1. **Device Display Mode.** Selects the viewing mode for UC Surface:
  - **Mixer.** While in Mixer Display mode, you have access to every function, making it great for remote mixing.
  - **Fat Channel.** Fat Channel Display mode is designed to function as a second screen for your mixer. In this display mode, all the Fat Channel features for each channel will be displayed rather than every function on the mixer. You can select a different channel to view either from your mixer or from the meter bridge in UC Surface.
  - **Sends.** Aux Sends mode provides two display options. While on inputs, UC Surface will display all the bus sends for the selected channel. While on outputs, UC Surface will display all the channels for a selected bus as well as the bus master. Use the meter bridge to select a different channel or bus.
  - **Meter.** Meter mode displays all the channel meters and mutes for every input channel and output bus.
2. **Sync Select.** Syncs channel selection between the mixer and across all devices running UC Surface.
3. **Sample Rate.** Sets the sample rate for your mixer.
4. **Global Aux Mute.** Controls channel mutes per mix. Setting Global Aux Mute to “No” will allow you to mute your channels per mix.
5. **Peak Hold.** Sets the type of metering. StudioLive mixers offer both Peak and Peak Hold metering. To view the Peak Hold, simply enable this preference.
6. **Default Fader Locate.** Enables Fader Locate mode if a fader movement is made from UC Surface. It is highly recommended that you leave this feature enabled if you are remotely controlling your StudioLive AI-series console mixer from a tablet using UC Surface.
7. **Phones Monitor.** Sets source for the headphone and Control Room outputs.
8. **Solo Mode.** Sets the solo behavior:
  - **Latch.** Multiple channels and buses can be soloed at the same time.
  - **Radio.** Only one channel or bus can be soloed at a time.
  - **CR.** Soloing any channel will patch the Solo bus to the Monitor bus.

9. **Solo PFL.** Turns PFL soloing on or off.
10. **Color Scheme.** Luminosity presets to compensate for environmental light interference.
11. **Show Edit Popup.** Presents a large display of parameter value for each function
12. **Colorize Channels.** Allows you to add custom colors to channel strips.
13. **Channel ID.** Choose between Icon only or Icon with channel number.

## 9.2 Networking

### Network

The Network tab in UC Surface allows you to manage the network settings for you StudioLive mixer, including managing your Wired Connection settings and configuring stage boxes as well as other AVB peripherals.

*Note: AVB Devices like NSB-series stage boxes and the EarMix 16M are not compatible with StudioLive AI-series mixers. These products are only compatible with StudioLive Series III mixers and other 1722.1 compliant AVB products.*

### 9.2.1 Wired Connection

When hardwired to a LAN network via Ethernet, there are three types of IP configuration schemes available from within UC Surface. Configuring your IP address allows you customize how your StudioLive mixer will present itself to other devices on the network. In most cases, you will use the default Dynamic IP mode setting.

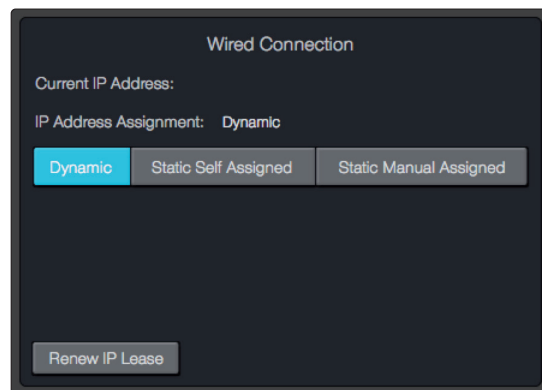

**Dynamic Mode.** This is the default setting for StudioLive mixers and is the most common way you will use your mixer on a network. In Dynamic IP mode, the mixer is assigned an IP address by a DHCP server. Because of this, Dynamic IP mode requires that your StudioLive be connected to a network that also has a router connected.

In this mode, your mixer will request an IP address from the DHCP server when it is powered on. The DHCP server will then answers and assign the mixer a unique IP address. The mixer will continue to send and wait for an answer to its DHCP requests.

**Static Self-Assigned Mode.** When two network devices are directly connected to each other or a switch, rather than to a network router, they cannot have their IP addresses assigned dynamically. In this case, the devices must be able to self-assign their own IP addresses.

The most common direct Ethernet connection scenario is while using a StudioLive Series III console mixer connected directly to your computer to utilize DAW mode.

In this mode the mixer will automatically assign itself an IP address in the 169.254.0.0/16 range, allowing connection with other devices in the same IP address range.

**Static Manual Mode.** This mode is typically reserved for more complex networking installations or situations that otherwise require setting static IP addresses. In this mode, you can manually assign an IP address, subnet mask, and gateway. If you're not sure how to manually configure static IP address assignments, please consult your IT administrator before attempting to configure your StudioLive mixer in Static Manual IP Address mode. Unless you have a specific need for static

IP address assignment, most users would be advised to use Dynamic mode and let IP addressing be handled automatically by your router/network DHCP server.

**Power User Tip:** Network modes are not intended to be changed on the fly. To ensure proper network configuration and connection, always power cycle your StudioLive mixer after changing its IP assignment mode.

### 9.2.2 Stagebox Setup (StudioLive Series III only)

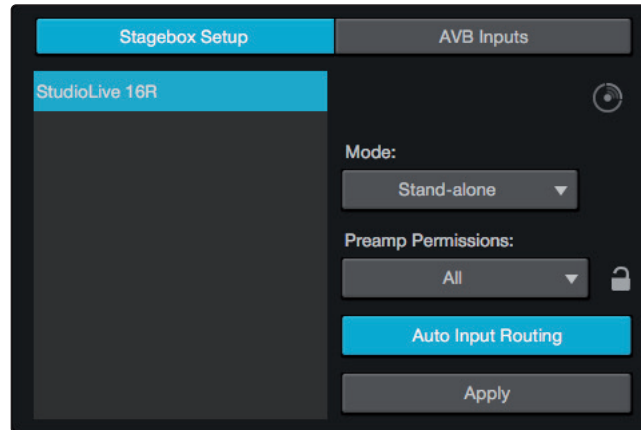

StudioLive Series III rack mixers can be configured as stage boxes for StudioLive Series III console mixers using the touchscreen on your console mixer or from UC Surface. The Stagebox Setup area on the Networking tab mirrors the same functions that are available from the touchscreen on your console mixer.

To configure you rack mixer, select it from list at the left.



If you have more than one rack mixer connected to the network and are unsure which mixer is which, you can press the Identify button. This will flash the front panel LEDs on whichever mixer is currently selected.

Select the Stagebox Mode you would like to use and click or tap the Apply button.

**Power User Tip:** Connecting to your mixer and selecting the mode can be one or two steps. When Apply is pressed, both the selected mixer and the selected Stagebox Mode are saved simultaneously.

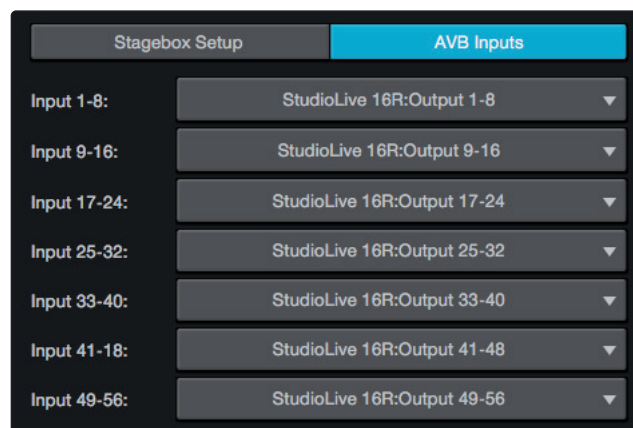

To route your streams, use the AVB Inputs tab.

For complete information on Stagebox Modes and AVB Inputs routing, please review the StudioLive Series III Stagebox Mode addendum.

### 9.2.3 EarMix Setup (StudioLive Series III only)

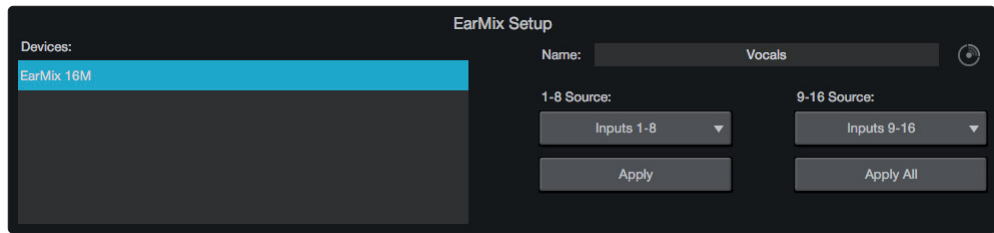

EarMix 16M Personal Monitor Mixers can be connected and configured from the EarMix Setup area on the Network tab. For complete instructions, *please review your EarMix 16M User Manual*.

### 9.2.4 Wireless Connection (StudioLive AI-series only)



When using the wireless LAN adapter with your StudioLive AI-series mixer, this section will display both your mixer's current IP address and the wireless network to which your mixer is currently connected.

Wireless Connection

By default, your StudioLive AI-series mixer is set to connect to a wireless network named "studiolive" with a password of "studiolive." To change the wireless network to which your StudioLive AI-series mixer, click on the Wireless Settings button.

### 9.2.5 Cascading Mixers (StudioLive RM/RML mixers)

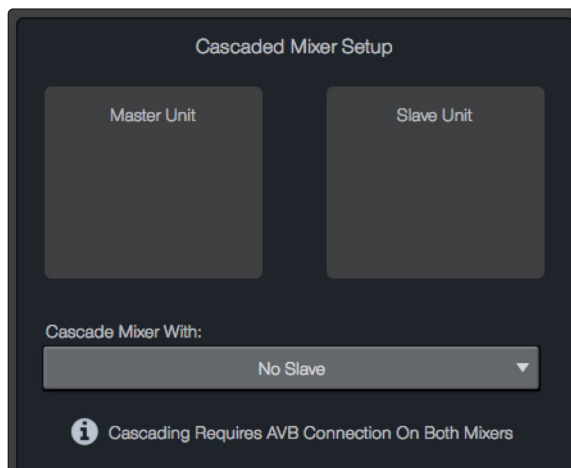

There are a few different ways to use cascaded RML-series mixers. For all configurations, you'll need to connect the mixers via Ethernet using a compatible AVB switch like the PreSonus SW5E.

In the Cascading Mixer Setup section of the Network tab, select the mixer you'd like to be Channels 33-64 from the drop-down list.

*Note: Establishing the cascaded connection may take several seconds. When complete, you'll see each mixer displayed in the Master and Slave unit spaces.*

Once your mixers are cascaded, they will function as a single 64-channel mixer. The tab at the top of the screen for the slave mixer will go away and when looking at the mixer view in UC Surface, you will see 64-channels. Channels 1-32 will reside on the master mixer, and Channels 33-64 will reside on the slave.

To remove the cascade, select None from the “Cascade with mixer” drop-down list.

If you’re using a StudioLive CS18AI, select either mixer from the drop-down list in the UCNET screen, and you’ll have control of both mixers as a single 64-channel system.

### 9.3 Backup

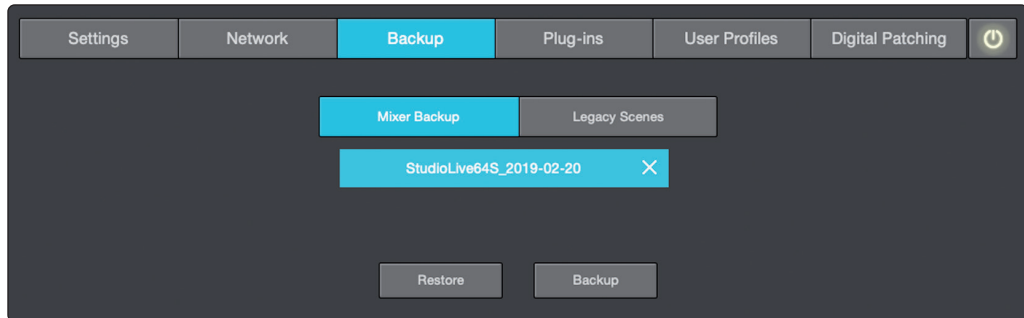

The Backup tab displays any backup logs that have been created in UC Surface. The Backup tab allows you to create complete, time-stamped snapshots of your StudioLive. This can be especially useful when completing a project that may need to be revisited in the future.

To create a backup, simply click on the Backup button.

To restore any backup file, select it and click the Restore button.

### 9.4 Plug-ins (StudioLive Series III Mixers)



StudioLive Series III Fat Channel Plug-ins allow you to enhance your StudioLive® Series III mixer and Studio One® Fat Channel with additional processor models. These plug-ins are virtual signal processors that load in your StudioLive Series III console or rack mixer’s Fat Channel, expanding your compressor and EQ processor libraries. Each plug-in comes in both StudioLive Series III format and Studio One format so you can use your new processor on your computer and in your mixer.

The Classic Studio, Modern Classics, and Vintage Channel Strips bundles are available individually from your authorized PreSonus dealer or from [shop.presonus.com](http://shop.presonus.com). Or buy all three bundles—12 processors in all—in the Fat Channel Collection, Volume 1, to supercharge your StudioLive Series III mixer and Studio One®.



9.5 User Profiles (StudioLive Series III Mixers)

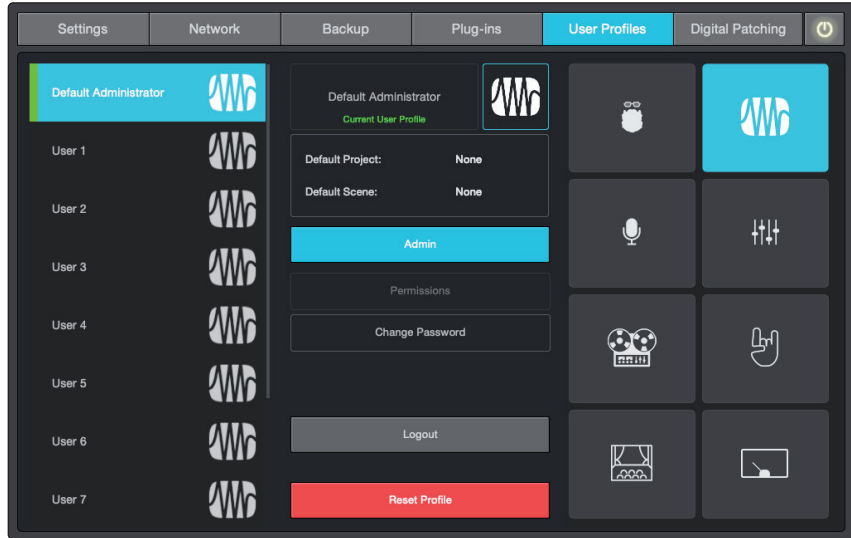

User Profiles allow you to create custom settings limiting access to certain functions. A specific project and scene can also be assigned to each Profile so that when the user logs into the mixer, they will have the option to load their preferred configuration.

9.5.1 Default Administrator

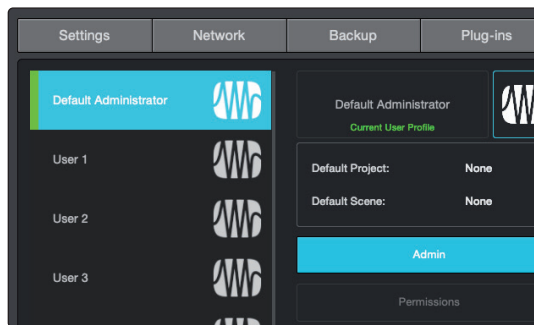

User Profiles must be activated on your mixer. By default, your mixer is logged into the Default Administrator profile. This profile has access to every setting and parameter on your mixer.

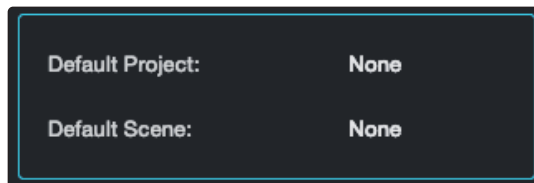

A default Project and Scene can be added to the Admin profile, click or tap to edit. Several customized settings can be added to the Default Administrator profile.

Once a project is selected, you can select a default Scene from within it.

**Power User Tip:** You can set the Default Project and Scene simultaneously, by selecting either option. While any Project can be set as the default, only Scenes within the Default Project can be chosen as the default.

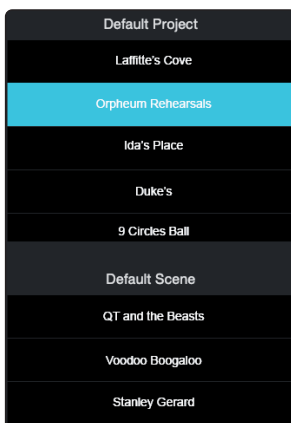

### Add a password

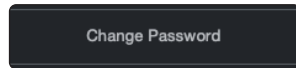

Click or Tap on the Change Password button to password protect the Default Administrator profile. If you log out of this profile, you will be prompted to enter the password to log back in.

### Reset Profile



To reset the profile to default state, press the Reset Profile button.

## 9.5.2 Creating a New Profile

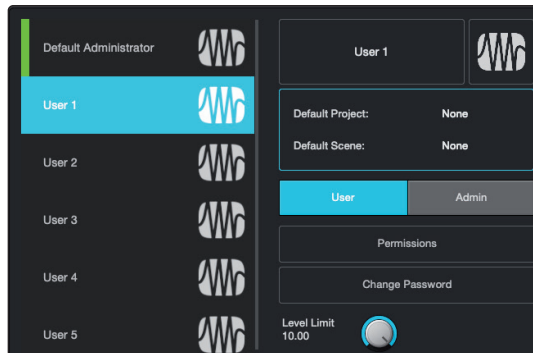

You can create up to 10 User Profiles in addition to the Default Administrator profile. To customize any profile, simply select it from the list.

**Power User Tip:** You must be logged into an administrator (default or custom) to create a new User Profile.

### Select a Name

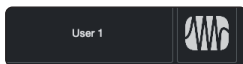

Tap on the default name field to enter a custom profile name. The only name that cannot be changed is the Default Administrator.

### Select an Avatar

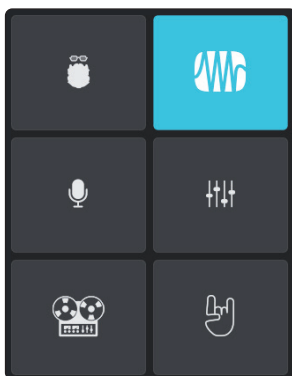

By default, the PreSonus logo is the avatar for every user. This can be changed by tapping the default avatar on the profile settings page.

### Profile Type



You can create two different Profile Types: Admin and User. Admin profiles are given access to every function and parameter. User profiles can have their permissions limited. For more information on setting User Permissions, *see Section 12.2.3*.

### Default Project and Scene

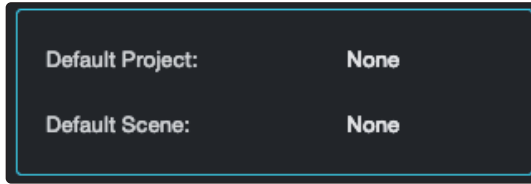

Just like for the Default Administrator profile, you can select a Project to be loaded when someone logs into their User Profile. This is especially useful for less experienced users.

Tapping on either the Default Project and Scene field will open the User Profile Default Project/Scene list. From here you can select the Default Project and Scene.

*Note: While any Project can be selected as default, only a Scene that is stored within the designated Default Project can be selected.*

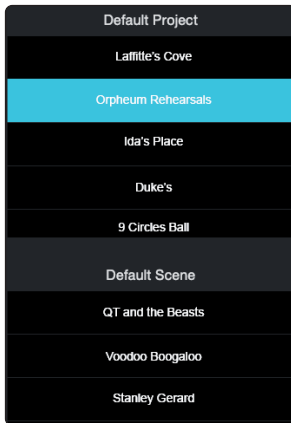

### Change Password (Optional)

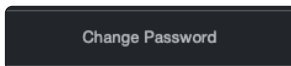

Click or Tap on the Change Password button to password protect the profile. If you log out of this profile, you will be prompted to enter the password to log back in.

### Reset Profile.



To reset the profile to default state, press the Reset Profile button.

## 9.5.3 Edit User Permissions

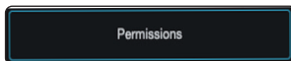

When a User Profile is set to "User," permissions can be granted for certain functions and denied for others.

The following features are only accessible from Administrator Profiles and always locked out in every User Profile:

- System Settings
- Audio Routing Options
- Input Source Patching
- UCNET Options
- Scene Lock / Unlock

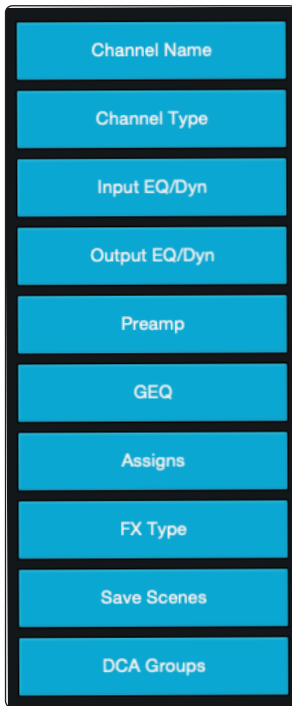

From the Edit Permissions screen, you can limit access to the following functions on a per User basis:

- **Channel / Bus Names.** This locks the ability to rename any Channel or Bus.
- **Channel Types.** This locks the ability to change the Channel Type.
- **Input EQ/Dynamics.** This locks the ability to control Gate, Compressor, EQ, and Limiter parameters for every input channel.
- **Output EQ/Dynamics.** This locks the ability to control Compressor, EQ, and Limiter parameters for every output bus as well as Output Delay.
- **Preamps.** This locks the ability to adjust the Input trim, Digital Gain, Phantom Power, Polarity, High Pass Filter, and Input Delay.
- **GEQ.** This locks the User out of the GEQ menu completely.
- **Assigns.** This locks the ability to make any channel assignments to the Main bus or Subgroups.
- **Changing FX Types.** This locks the ability to change the effects types loaded into the StudioLive Series III Effects Rack.
- **Save Scenes.** This locks the ability to save or create new scenes.
- **Changing / Adding DCA Filter Groups.** This locks the ability to create or alter DCA Filter Groups.

9.6 Digital Patching (StudioLive Series III only)

Digital patching allows you to route any analog or digital input to any channel and any mix to any output. This can save you hours of frustration having to rewire and repatch your physical inputs and outputs, especially in a fixed installation. Digital patching also allows you freely route audio to your AVB network and record anything you'd like via USB.

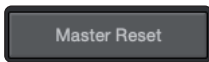

Press the Master Reset to reset all routings to their default state.

9.6.1 Input Source

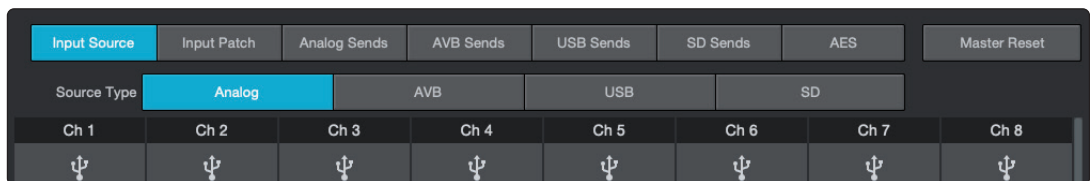

Selecting the Input Source tab will allow you to patch any source type to any channel. This also provides you with a global view of what type of source is routed to each channel, as well as allows you globally configure all of your source routings for each type. For example, while the USB tab is active, you can patch every desired USB return to every channel on your mixer.

### 9.6.2 Input Patch

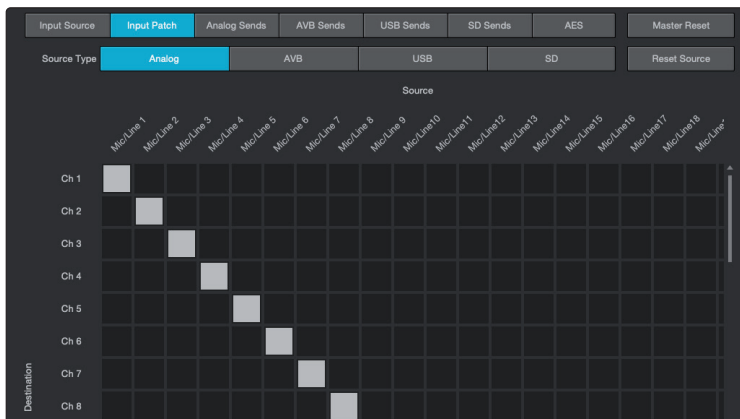

From the Input Patch tab, you can route any input to any channel. This allows you to select the sources for all input types (Analog, AVB, USB, and SD). From this menu, you can, for example, route Analog Input 10 and USB Return 17 to Channel 1 on your mixer. You can then toggle between the two sources using the USB and Analog source controls for your mixer.

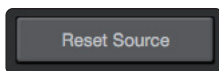

Pressing the Reset Sends button will reset the default routing.

**Power User Tip:** The routing you select for each source type is saved. In this way, you can switch between custom Analog, Network, and USB routings just as you can with the default routings.

### 9.6.3 Analog Sends

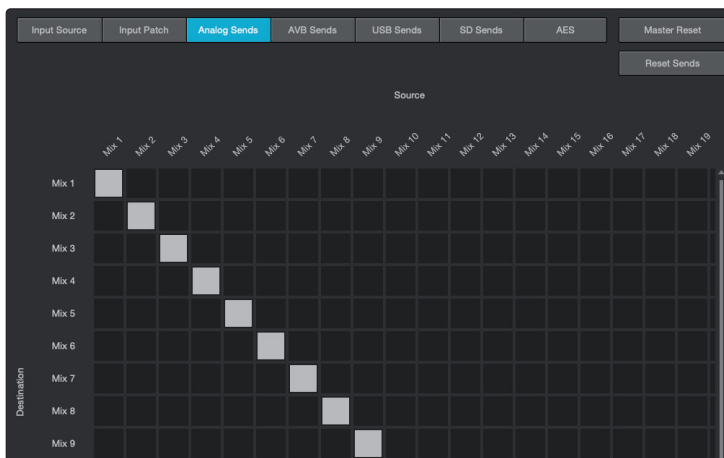

Selecting the Analog Sends tab will allow you to patch any mix (FlexMix, Subgroup, FX Mix, Main Left, Main Right, Solo Left, or Solo Right) to any FlexMix output.

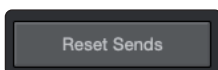

Pressing the reset button will reset the default routing for the currently selected input type.

### 9.6.4 AVB Sends

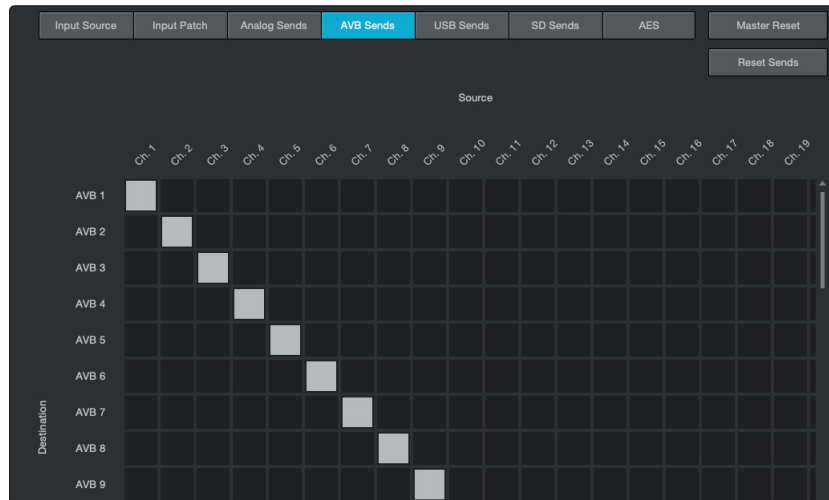

Selecting the AVB Sends menu will allow you to patch any channel send or mix to any AVB output.

Pressing the Reset Sends button will reset the default routing.

The following local StudioLive sources can be sent out to the AVB Network:

- Every Input Channel
- Aux In A L and R
- Aux In B L and R
- Tape In L and R
- Talkback
- Every FlexMix
- FX Send Mix A-D (pre-effects processor)
- Subgroup A-D (32-channel models only)
- Main Mix L and R
- Main Mono/Center (StudioLive 64S)
- Solo L and R

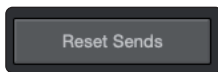

### 9.6.5 USB Sends

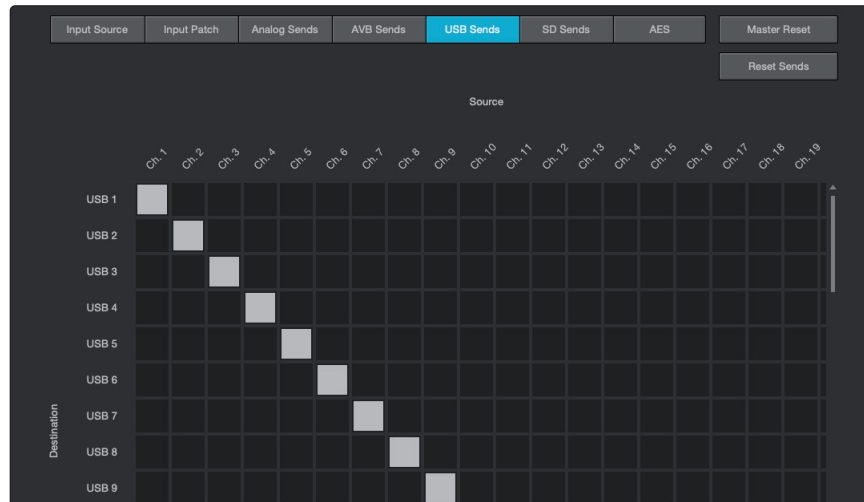

Selecting the USB Sends tab will allow you to patch any channel send or mix to any USB driver send.

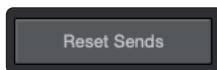

Pressing the Reset Sends button will reset the default routing.

The following local StudioLive sources can be sent to the USB bus to be recorded in your favorite DAW application:

- Every Input Channel
- Aux In A L and R
- Aux In B L and R
- Tape In L and R
- Talkback
- Every FlexMix
- FX Send Mix A-D (pre-effects processor)
- Subgroup A-D (32-channel models)
- Main Mix L and R
- Main Mono/Center (StudioLive 64S)
- Solo L and R

### 9.6.6 SD Sends

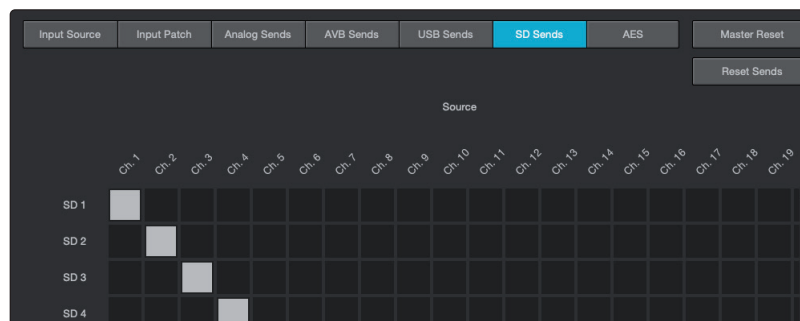

Selecting the SD Sends tab menu provides routing the onboard SD recorder as follows:

- **StudioLive Series III 32-channel models.** This router allows you to patch any mix to the last stereo pair of SD Card recording inputs (33-34). The Main Mix, any FlexMix pair, or any fixed Subgroup pair can be routed to these tracks on your SD Recorder.



- **StudioLive 64S.** Because the StudioLive 64S is equipped with more channels than the onboard SD Recorder can record, the SD Sends router allows you to route any channel or bus to any of the 34 available tracks.

Pressing the Reset Sends button will reset the default routing.

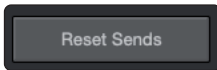

### 9.6.7 AES

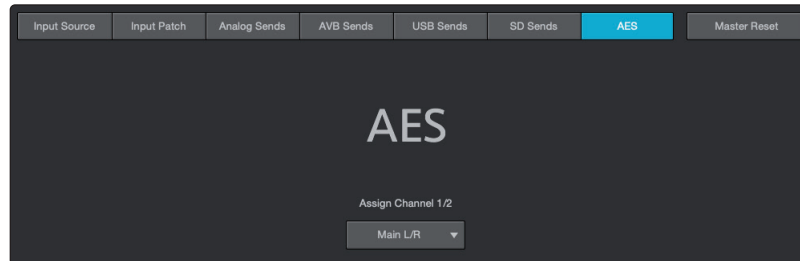

Selecting the AES tab allows you to route any mix pair to the AES output on your StudioLive mixer.

## 9.7 Aux Routing (StudioLive AI-Series Mixers)



In addition to the 32/24/16 input channels, the StudioLive AI-series mixers allow you to route a number of other buses and other inputs. This is done via the Aux Router tab. To route these additional digital sends, simply patch them to a stereo pair of auxiliary inputs of your choice. Remember, all of these buses and inputs are automatically set to send their signals post-Fat Channel dynamics and post-EQ (where applicable). The inputs and buses selected in the Auxiliary Input Router will be displayed in your recording application, along with the name of their routing.

The Aux Router also allows you to designate a specific bus to the S/PDIF output and enables you to select which stereo pair will be recorded on the auxiliary stereo track in Capture.

As previously mentioned, if Smart Spectra tools are engaged, UC Surface will take control of the second-to-last pair of auxiliary inputs. When Smart has control, these inputs will be grayed out.

## 9.8 Smart System Check Wizards (StudioLive AI-series only)

When connected to a StudioLive AI-series mixer, UC Surface includes three System Check Wizards to provide you with the ability to view the frequency response of the venue; quickly calculate and set delay system timing; and verify output connectivity.

**Note:** *Smart System Check Wizards are not available with StudioLive Series III consoles.*

Traditionally, in professional sound reinforcement, the mixing console is there to mix, and the system processor is there to align and tune the speaker system. When functioning and set correctly, the system processor is invisible to everyone but the System Engineer. For the first time, the tools used to tune and align speaker systems are built into the mixing console itself and accessible to any engineer who wants to improve their PA's sound and get the most out of their PA system.

For all but the most seasoned professional sound technician, this is a new extra step in the process of setting up for a show. For most FOH engineers, getting a good mix is a big victory. But imagine being able to recreate that same killer mix night after night, show after show. Once the system has also been optimized for the environment it is in, any FOH engineer working on it will achieve that big victory without so much work. This is why system alignment is a standard procedure in professional level sound reinforcement. Again, this solution is not typically achieved from the mixing console, but built into the system design itself. The Smart System Check Wizards in UC Surface merge these two worlds.

Clicking on the Smart Wizards tab in the Settings page will launch Smart System Check mode. While in this mode you can launch any of the following wizards:

- **SRA:** Smart Room Analysis generates a frequency-response trace and overlays it on the parametric EQ in UC Surface so you can adjust your system to get rid of unwanted anomalies in the room.
- **SSD:** Smart System Delay calculates and sets the correct amount of delay time between two full-range systems.
- **SOC:** Smart Output Check verifies that your system outputs are routed correctly and are passing signal.

To run any of the Smart System Check Wizards, UC Surface will need to take over your mixer. When you first click on the Smart Wizards, you will see a warning to this effect.

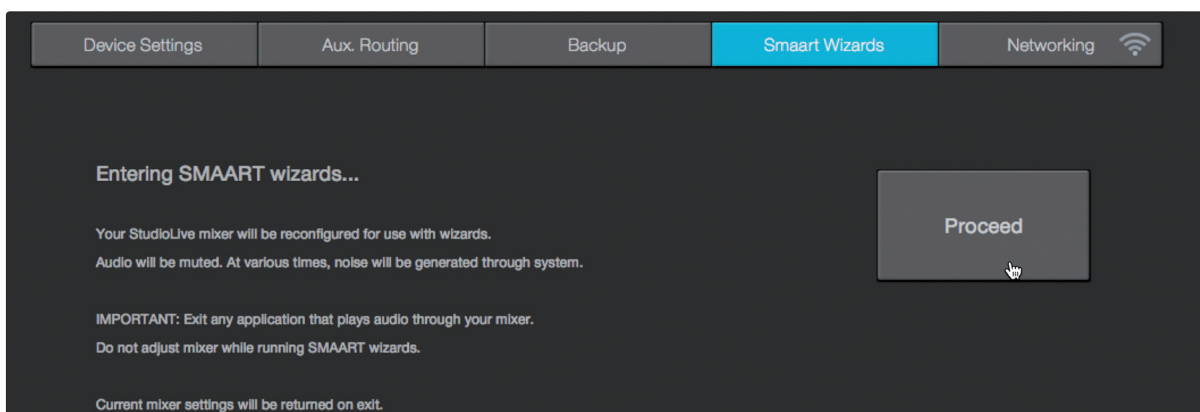

Clicking on the "Proceed" button will launch the Wizard select window and you will no longer have control over your mixer. You can exit the Wizards and regain control at any point simply by clicking on one of the other tabs or closing the Settings Page.

**Note:** *To run the SRA and SSD wizards, you will need to connect a measurement microphone to your StudioLive's Talkback input. You'll also need a mic stand and a long enough cable to place the mic in front of your speakers.*

A measurement microphone is special type of condenser microphone that is designed to provide an accurate reproduction of a room's sound characteristics for use with audio-analysis tools, such as RTAs and spectrographs.

Measurement microphones typically have an omnidirectional polar pattern and deliver a very flat frequency response between a low end of 5 Hz to 30 Hz and a high end of 15 to 30 kHz. While measurement microphones can be quite expensive, most affordable models will do the job nicely when paired with the Smart System Check Wizards. PreSonus offers the budget-priced PRM1 Precision Measurement Microphone for this purpose.

### 9.8.1 Smart Room Analysis Wizard

The SRA Wizard is an automated process that will guide you through the steps of acquiring a frequency-response trace for your audio system. A frequency-response trace is the plotted result (frequency and amplitude) of the system measurement. This measurement is calculated using Rational Acoustics' transfer function, which is a set of proprietary algorithms that compare the signal from a measurement mic to computer-generated pink noise.

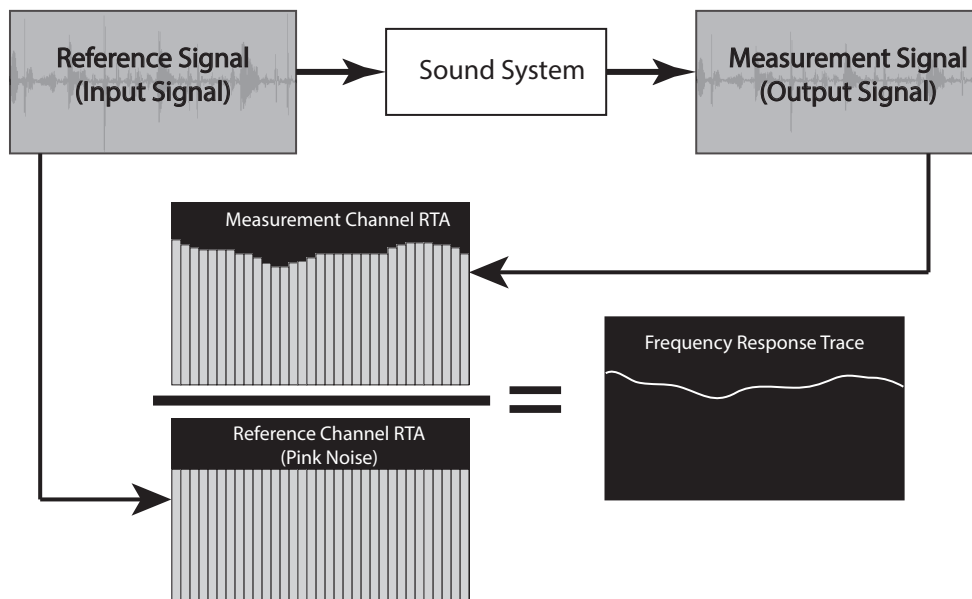

To launch the Room Analysis wizard, click on the Room Analysis tab and follow the onscreen instructions. Click OK to start the wizard.

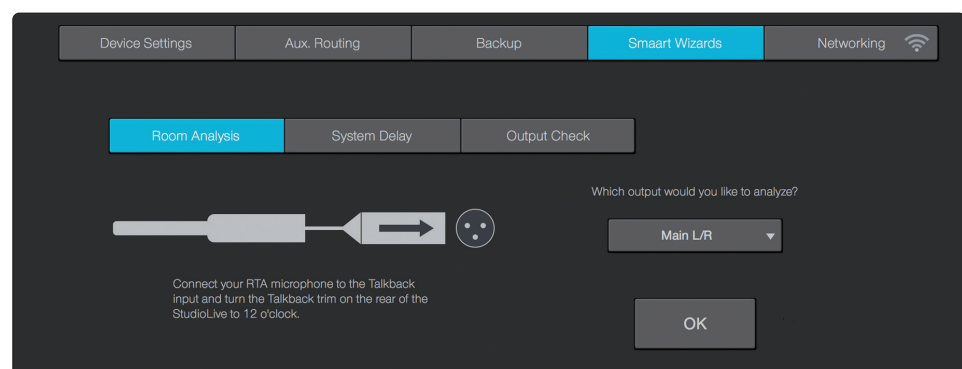

Next you will be asked to pick the type of analysis you would like to do. Basic Analysis requires you to take a single measurement of your system. When analysis is complete, the wizard will continue to output pink noise through your system while you EQ, allowing you to view the effects of your filters in real-time.

Advanced Analysis requires you to take three separate measurements and will generate a more accurate frequency-response trace of your system by averaging the measurements together. Once the trace has been generated, this wizard will not continue to analyze your system. To view the effects of your filters, you must run the wizard again. Skip to the next part of this section for more information on Advanced Analysis.

**Note:** StudioLive RM/RML users must first select a talkback input from the talkback channel. Once selected, this will be the input source targeted by the Smart Room Analysis Wizard.

### Basic Analysis Mic Placement

Place your microphone on-axis in front of the speaker you want to analyze. If you are analyzing a stereo bus, place your microphone on-axis in front of the Left speaker. *See Section 9.8.4 for tips in choosing the best primary mic position.*

### Advanced Analysis Mic Placement

As previously mentions, you will analyze your speaker from three different positions. For the first analysis, place your microphone on-axis in front of the speaker you want to analyze. If you are analyzing a stereo bus, place your microphone on-axis in front of the Left speaker. *See Section 9.8.4 for tips in choosing the best primary mic position.*

#### On-Axis

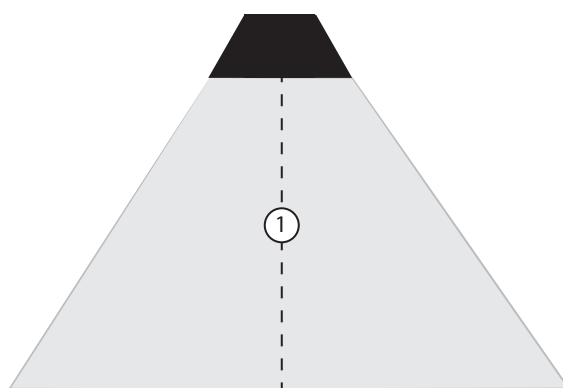

The next two measurements will be taken off-axis. Place your microphone off-axis in front of the same speaker. *See Section 9.8.4 for tips in choosing the best secondary and tertiary mic positions:*

#### Off-Axis A

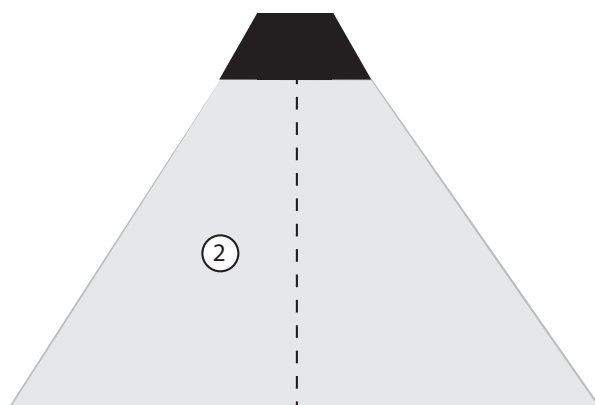

### Off-Axis B

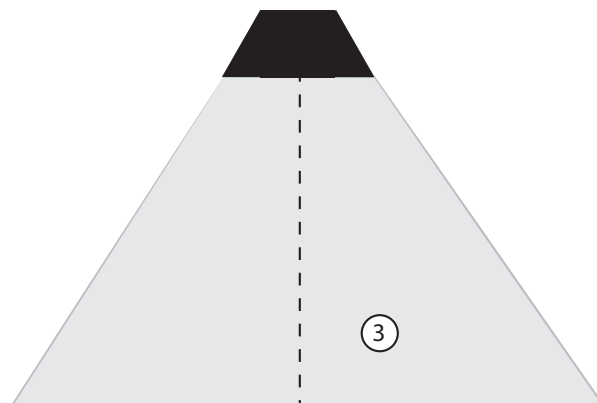

**Power User Tip:** In most cases, you will want to EQ the left and right side of a stereo system the same. This is why the SRA wizard asks you to measure the left side of your system only and linked buses are displayed as such. If you are in an unusual situation where you need to separately EQ each side (say, you are using a different model 15-inch speaker on the left side than you are on the right side), connect your system to a pair of subgroup outputs and do not link them.

### 9.8.2 Smart System Delay Wizard

Using multiple sets of speakers in a live performance can make a huge difference in the quality of the sound. Rather than relying on a pair of front-of-house speakers to fill the entire room, you can create listening zones throughout the room so that your front-of-house system only needs to be loud enough to cover the front of the room. This allows you to lower the level, give the front row listeners' ears a break, and get better fidelity from your speakers. Sounds great, right?

However, it's not as easy as just bringing an extra pair of speakers. Any additional sets of speakers will need to be delayed; otherwise the audience will perceive that the sound is coming from the walls, rather than from the stage. Even worse, since electricity travels much faster than sound, listeners in the rear of the room are likely to hear the sound coming from the nearest set of speakers before they hear the sound from stage, which can dampen the attack and intelligibility of the sound and create an unpleasant phasing effect. To compensate, you need to delay the signal going to the additional sets of speakers.

Sound travels at a rate of 1,130 feet per second, providing that the temperature, humidity, and air pressure are all "normal." Therefore, it takes 1 ms for sound to travel 1.1 feet. But what if you're setting up for an outdoor show in, say, Baton Rouge, Louisiana, in August, when the temperature and humidity are unpleasantly far above "normal"? Your calculations might be a little off, unless you happen to be a whiz at calculating the effect of barometric and atmospheric pressure on sound waves.

The SSD wizard is an automated process that calculates and sets the correct delay time between two full-range systems. The purpose of this wizard is to set the delay time for a secondary system that is being fed from one or more subgroups. No calculators, slide rules, or finger-counting are necessary!

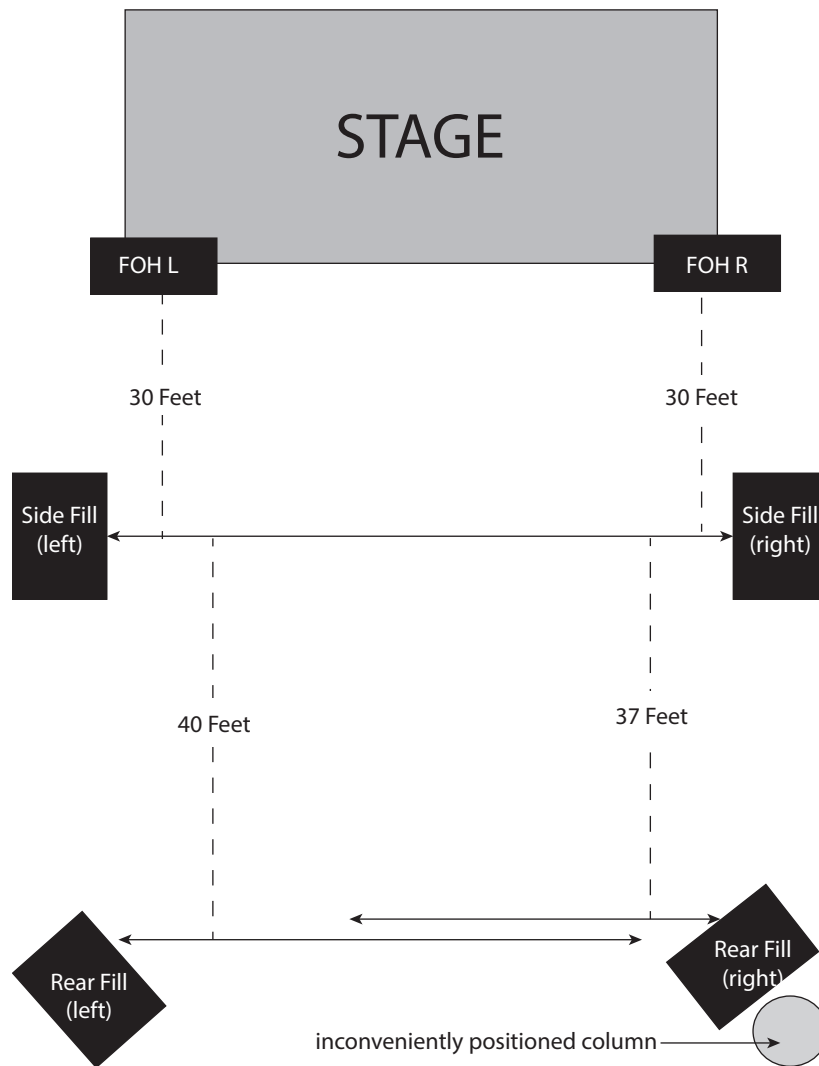

In the example, you see three sets of speakers: main front-of-house, sidefills for the middle of the room, and rear fills for the back. As a general rule, you should set the delay on a satellite system based on its distance from the next closest system to the mains. In this case, you'll set the delay on the sidefills based on their distance from the main front-of-house system and the delay for the rear fills based on their distance from the sidefills.

When using the SSD wizard for the above system, you would run the wizard four times. The first time, you'd use the main front-of-house left for the main system and the left sidefill for the delay system. The second time, you will use the left sidefill as the main system and the left rear-fill for the delay system. Then repeat the procedure for the right side.

**Note:** it is important that you set the delay on the first satellite pair before you set the delay on the subsequent satellite pair.

**Power User Tip:** Because rooms often have inconveniently placed architectural features—fire exits, tables, and so on—the left and right side of a system with satellites will rarely be equidistant on both sides of the system. Because of this, you need to run the wizard for each side of a stereo system, starting at the front and working your way to the back.

**Please note:** the SSD wizard is not designed to analyze systems that include a subwoofer. Temporarily disconnect or disable your subwoofer before beginning analysis.

System Delay Wizard

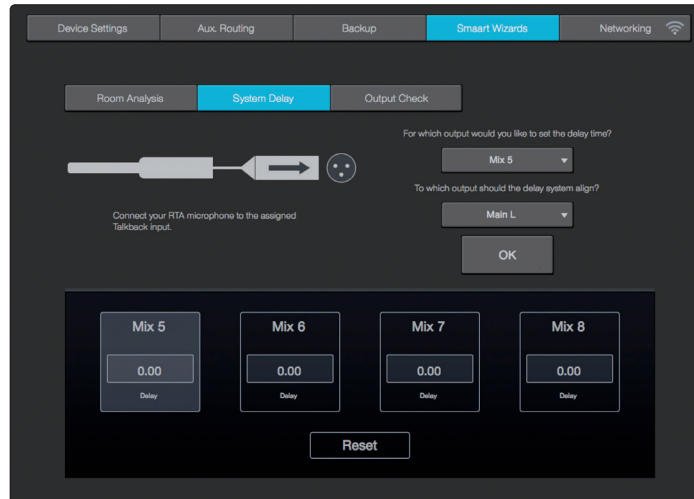

To launch the System Delay Wizard, click on the System Delay tab and select the speaker output you want to delay. From the bottom pull-down menu, select the speaker output to which you'd like to align. This can be your main outputs or any of the subgroup outputs, even if the subgroup outputs have been delayed. Click OK to start the wizard and follow the onscreen instructions.

**Note:** StudioLive RM/RML users must first select a talkback input from the talkback channel. Once selected, this will be the input source targeted by the Smart System Delay Wizard.

Once you have positioned and delayed your satellite system, you will want to match the output levels of the main and delay systems. To do this, use an SPL meter to match the output of the main and delay systems at the delay-system measurement position. This means that if you are standing 20 ft from the left side of the main system and 30 ft from the left side of the delay system, and the output of the main system is 85 dB, the output of the delay system should also be 85 dB.

**Note:** For delay times between 0 and 50 ms, the delay will be set to the nearest 0.5 ms; between 51 and 100 ms, the delay will be set to the nearest 1 ms; and between 102 and 300 ms, the delay time will be set to the nearest 2 ms.

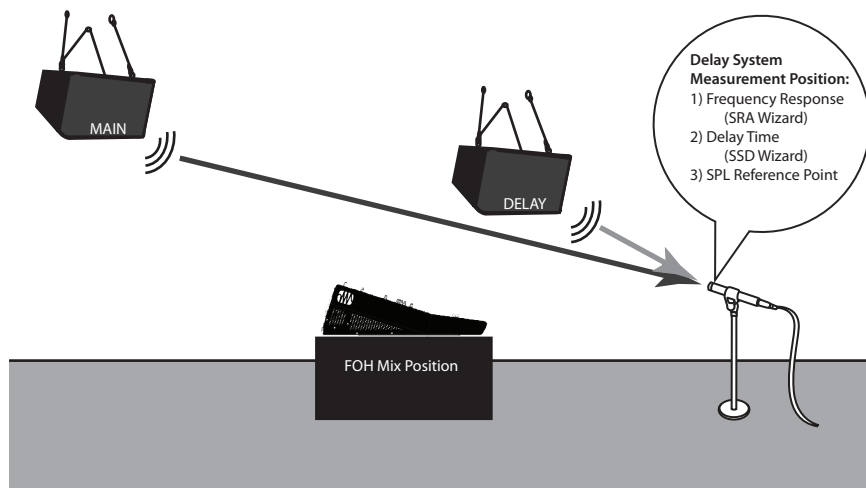

### 9.8.3 Smart Output Check Wizard

It's five minutes before a show, and suddenly the drummer says there's nothing coming out of his monitor. Or you do a friend a favor and run sound at her club because she has the flu, and you show up not knowing which aux is connected to what monitor or which sub is controlling what sidefill. The Smart Output Check wizard was designed to make these problems disappear like magic!

By momentarily taking over the routing and volume control of an output and patching pink noise to it, the Smart Output Check wizard lets you quickly discover which speaker is connected where and helps you quickly get to the root of a routing problem. In the case of the drummer with silent monitor, if he hears pink noise, you can save yourself ten minutes of frantic cable tracing only to discover the output level was inadvertently turned down on his aux mix.

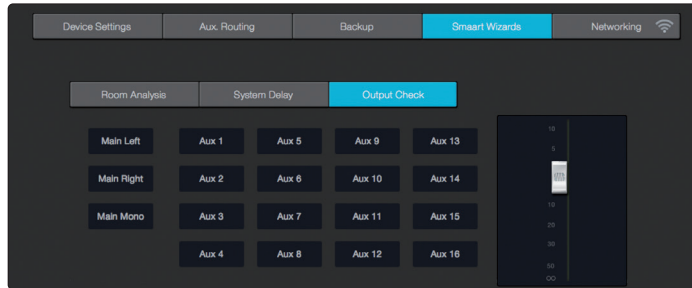

Click on the Output Check tab to use the Smart Output Check wizard. You will be shown buttons for all outputs on your StudioLive. Click on an output's button, and pink noise will fade in for three seconds. You can click on the button again to stop it. To adjust the pink noise, use the fader on the right side of the page.

### 9.8.4 Mic Position

The SRA and SSD wizards do all of the calculations and complex routing through the StudioLive for you. Two very important decisions are up to you: Where to place the mic and, in the case of the SRA wizard, what to do with the frequency-response trace.

Improper mic placement can create "problems" in your trace that actually don't exist in your sound system.

#### Primary Mic Position

This is the main reference point for a speaker and can be used as a single, "representative" position if you're short on time or patience and just want to get a "gut check" of your system.

Your goal in setting the primary mic position is to find a point that puts the microphone in the center (on axis) of a speaker's throw, within the listening area. In other words, you want to put the microphone smack dab in the middle of where your speaker sounds its best.

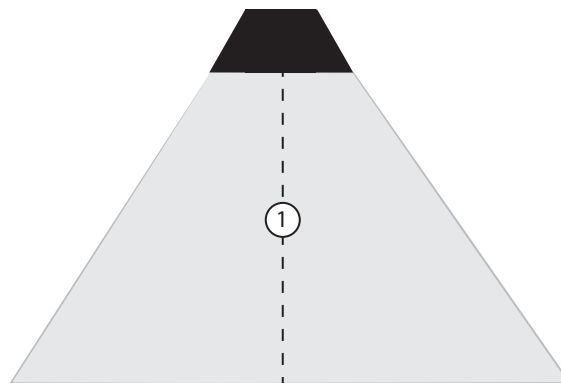



### Secondary Mic Position

You will use two different secondary positions in a multi-point measurement. These can be on- or off-axis measurements of a speaker within the listening area. This will allow the SRA wizard to create an average frequency response of your sound system. Avoid using locations outside the core coverage area of your system or on the edges. The graphic below displays some good secondary measurement positions relative to the primary position, as well as some positions that would be more problematic than useful. With any mic position, avoid creating position-related anomalies.

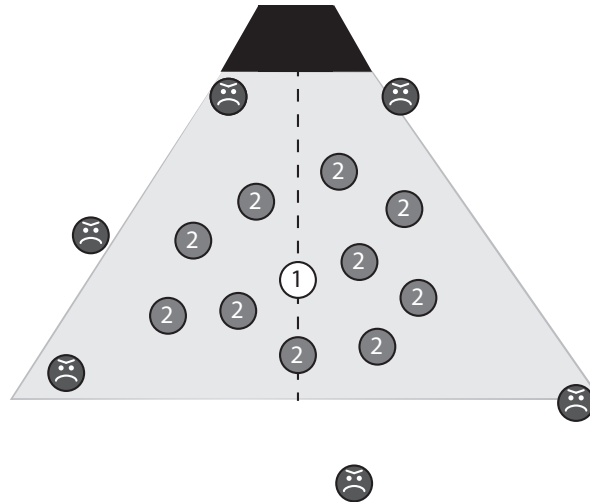

A word of caution about ground bounce: Ground reflections become an issue when a speaker is flown and angled down. The proper mic position, in this case, will also catch the reflection of the signal off the floor.

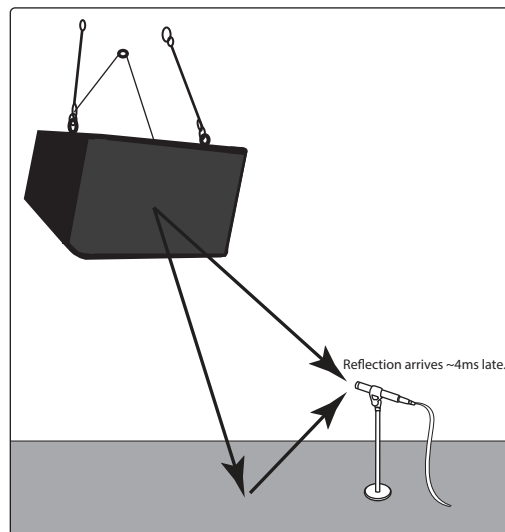

In this case, you can choose from three options:

- Block the reflection with a baffle that is large enough to be effective above 100 Hz (so at least 5' by 5').

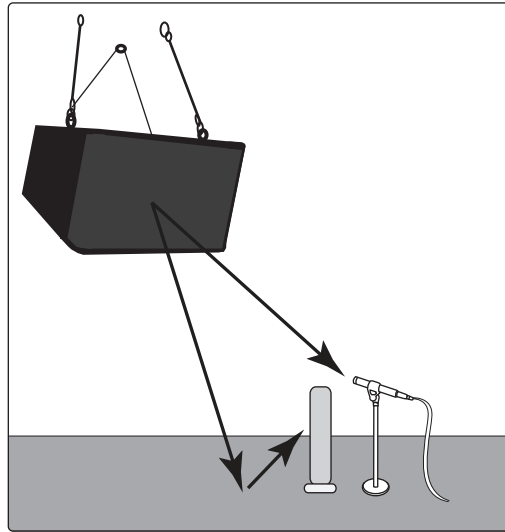

- Do a ground-plane measurement.

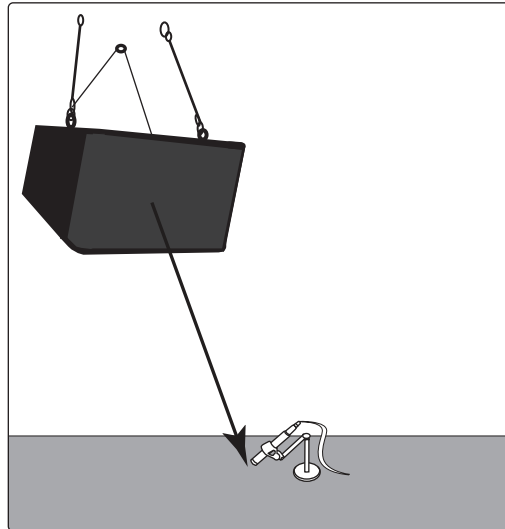

- Do a multi-point measurement. Enough measurement positions will randomize the effect of the floor bounce.

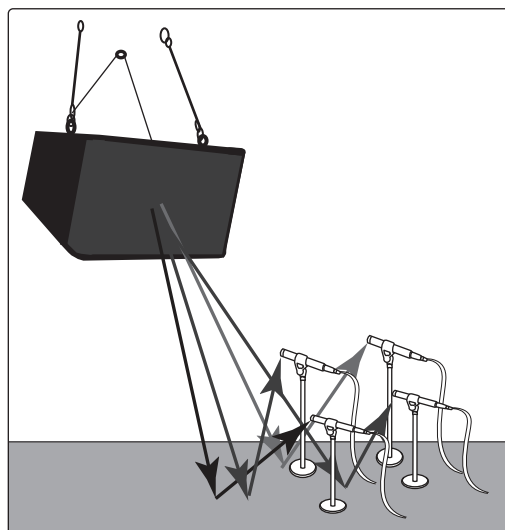

### 9.8.5 System Alignment Rules

The visual result of a sound-system test can be a powerful tool; however, like any powerful tool, you must be responsible about how you wield it. Here are few basic principles to follow:

**Solve the problem at its source.** The closer to the source, the more effective the solution will be. If your kick drum lacks punch in the mix, take a look at the kick-drum channel's EQ and dynamics processing. Is the kick drum properly tuned? Are you boosting the attack of the kick beater enough and at the right frequency? Is your compressor's attack too long?

**Use the right tool.** The system EQ is the last in a long line of possible solutions to frequency problems. Once you have fully assessed the problem, you can choose the right tool. Check the acoustic space, choice of equipment, and system design first. Obviously, you don't always have control over the acoustic design or treatment (or lack thereof) of a room, and your wallet might determine your choice of speakers more than your needs do, but usually you have some control over your sound system's design.

Can you raise the speakers to mitigate some of the harsher reflections? What about widening the stereo field?

After you've ruled out physical solutions to a sound problem, move on to level and delay. Can you simply lower the level of your subwoofer to kill some of the boom in the room? Can you delay your front-of-house speakers by a few milliseconds so that they're in alignment with the guitar cabinets blaring from stage?

If you can't find a physical solution and can't mitigate the issue with level and delay control, it's time to employ the system EQ.

**A frequency-response trace is not a video game.** Your goal is to fix your system and make it sound the best it can, not create an EQ curve that is an exact inversion of the frequency-response trace. Mix with your ears, not your eyes.

**An analyzer is a tool; you are the carpenter.** You decide where to measure your speakers. You decide what the resulting data means. You decide what (if anything) to do about it.

### 9.8.6 Using the Trace: Spotting the Trend

As discussed in the previous section, many factors can affect the response of a sound system: the room, system configuration, electronics, wiring, and more. Part of understanding what you see is knowing what you should not be seeing—or at least having a basic idea of what to expect. After all, you are trying to sculpt the EQ curve of the system into something that compliments that sound system's frequency response.

For example, a small system without a subwoofer can't reproduce much energy below 50 Hz. In fact, this frequency cutoff could be even higher, depending on the size of the speaker, its factory tuning, porting, etc. This means that if you are analyzing a system that is comprised of two 2-way, 12" powered speakers, you should expect your frequency-response trace to drop off around 50 Hz or so (depending on the frequency response of your speakers). Because of this, boosting low frequencies in this type of system wouldn't achieve much and may introduce more problems than it would solve.

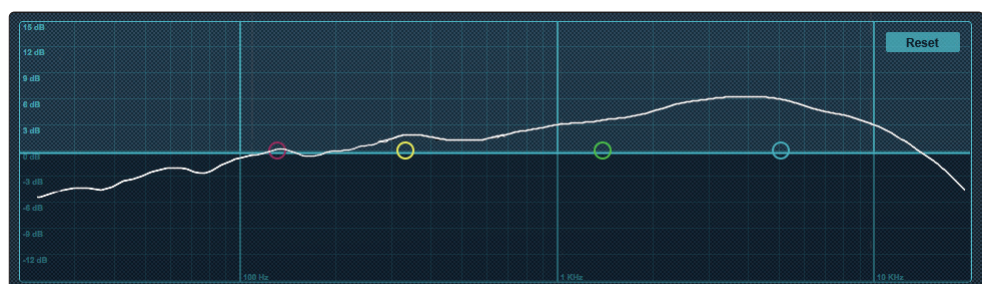

**Power User Tip:** A subwoofer can significantly change the frequency response of a full-range system. A 3-way system with a subwoofer will be 6 to 18 dB hotter below 80 to 100 Hz than a 3-way system without a subwoofer. Keep this in mind when viewing your trace.

Different types of live performances make different demands of a PA system. A classical concert has very different needs from a rock concert. Just as you wouldn't mix an evening of Bach quartets the same as an evening of thrash metal, you don't want to tune your PA system the same for both types of events.

A classical concert doesn't need an exaggerate subwoofer output. The audience and performer expect and want a natural reproduction of the music. In contrast, systems that are tuned for a rock show will use subwoofers essentially as an effect. This is how they achieve those pummeling kick and toms and huge bass guitar sound: the system is pre-tuned with more bass response.

In other words, you can stack the deck to be assured of a big FOH mix win. In system alignment, this deck stacking is called "trends." Every genre and performance type requires a different type of trend. The sole objective of a system EQ is to smooth out the sound system by creating a uniform slope that the system EQ follows. This will give your system a more uniform sound and performance, as well as better clarity, because your system has been pre-EQ'd to meet the needs of the concert.

Below are some examples of trends for various applications:

### Music Concert

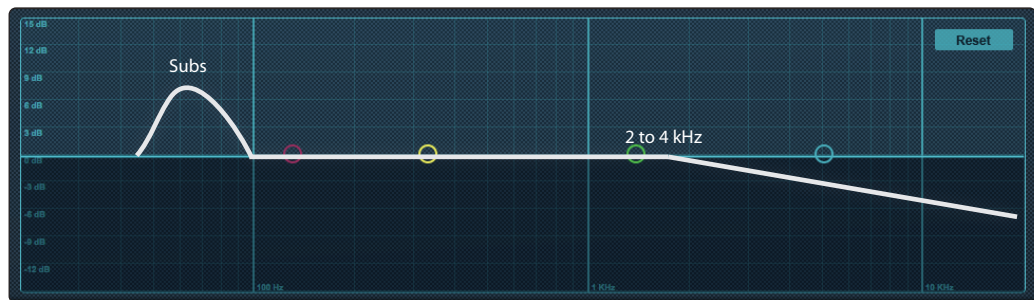

### Rock Concert

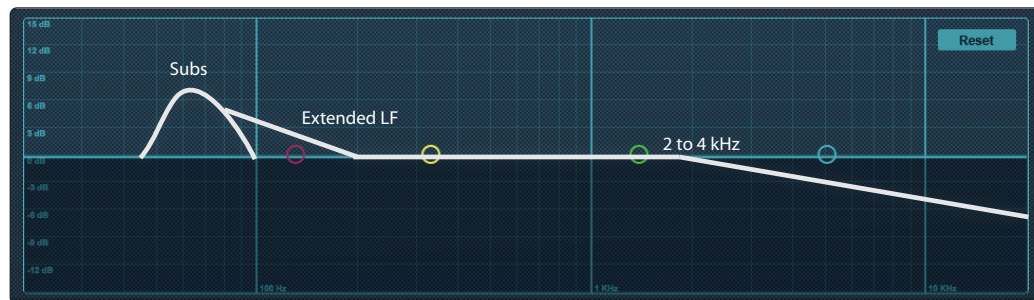

### Music Playback/Reproduction

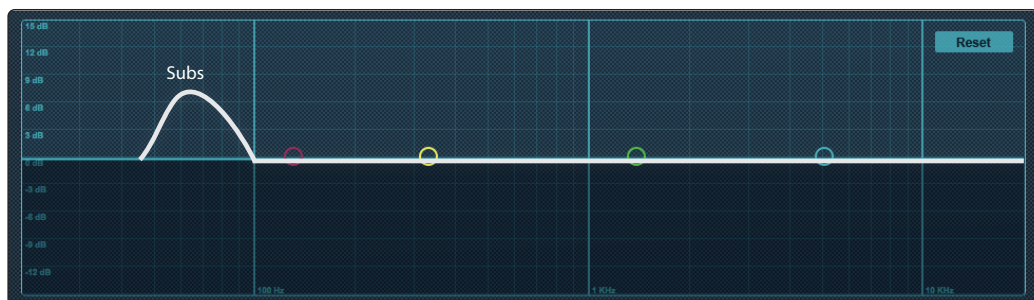

### Speech Intelligibility

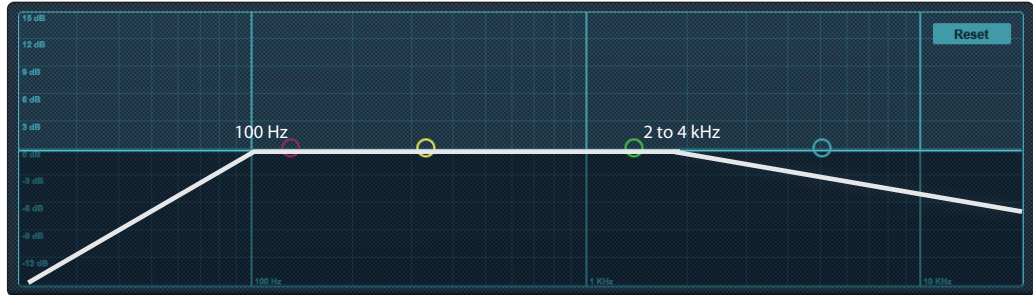

***Power User Tip:** The amplitudes depicted in the trend examples shown here are guidelines: examples of very general slopes required for different applications. The desired value will be different for every gig, and it is ultimately up to you to decide what is required for your show, based on what type of artist is performing and what kind of sound system you are using. While making a trace follow these trends is recommended, in real-world applications, this might not always be possible. Being able to compromise and work with what you have, often requires a certain amount of creativity and artistry on the part of the system engineer.*

#### 9.8.6.1 Spotting the Trend: Real World Example

Let's take a look at the following frequency-response trace. In this example we can see a few peaks that don't go along with our application; for our purposes, let's make that a music concert.

Our goal is to get from this:

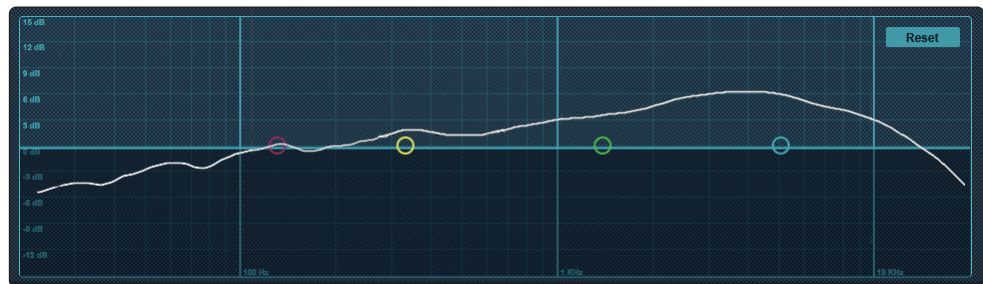

to this:

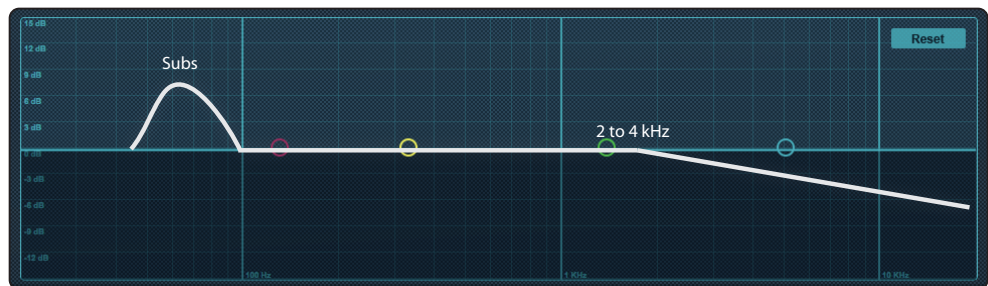

...all the while keeping in mind that we cannot alter the speaker's frequency-response curve, even if we would like to.



Looking at our trace, it's easy to spot a few problem areas. There's a bump at 300 Hz that could be smoothed out a bit. Another bump at 750 Hz could stand some flattening, and a big rise at 1 kHz to 10 kHz is going to make our system shrill at higher volumes.

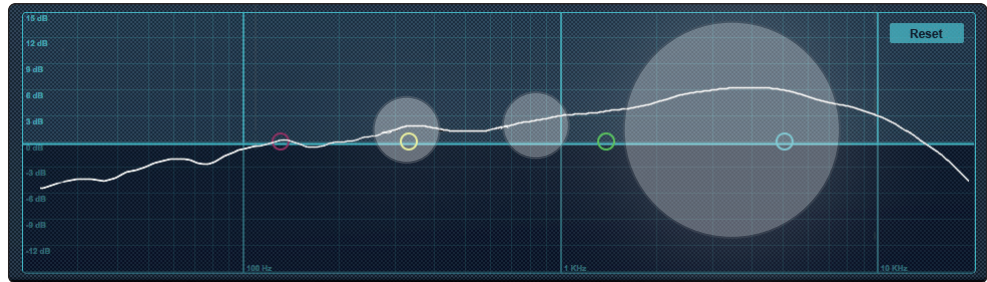

What about all the other bumps and dips? Remember: The frequency-response trace is not a video game. You don't need to put a filter on every bump or dip in your trace when a few carefully placed filters will achieve a much better result. This is also why the wizard overlays the trace on your parametric EQ.

A parametric EQ is an ideal tool to shape your system's frequency-response trace into a trend that will complement your application. With a parametric EQ, you have the ability to process large areas of bandwidth, with minimal electronic smearing to the signal. This also frees up your graphic EQ for aesthetic adjustments or fine-tuning.

So, let's apply the following EQ setting and take a look at the resulting frequency-response trace:

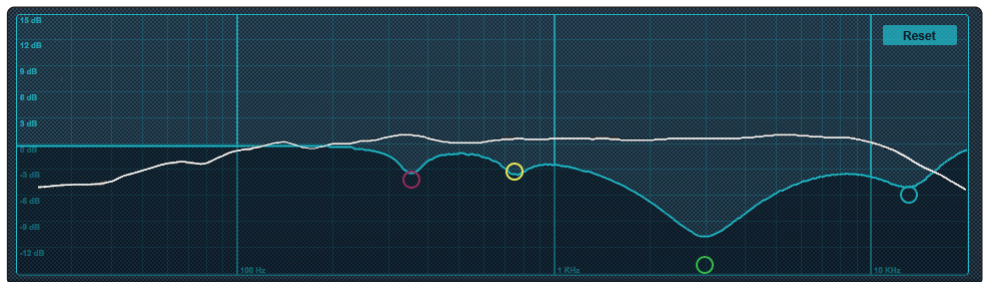

As you can see, just four filters made a big difference, and now our system's frequency-response trace follows the general Music Concert trend that we needed.

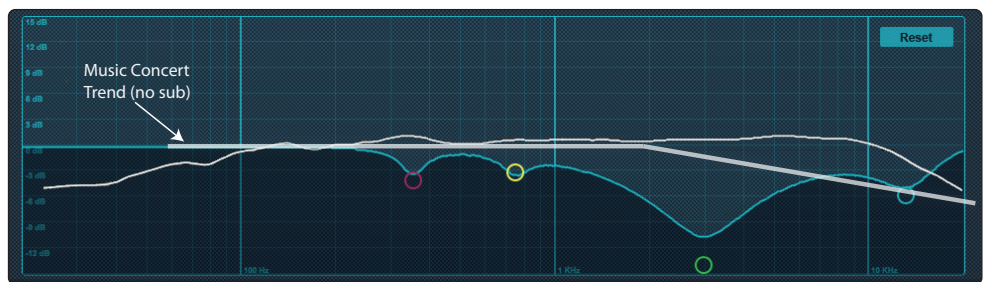

**Power User Tip:** Spotting the trend and knowing what to do with it are experiential skills that get better over time. Because of this, you may try using the trends in the previous section as practice tools. Shoot your room with the SRA wizard and try to EQ it for speech intelligibility, then play an audio book or a recording of your favorite inspirational speech through your system. Turn the EQ on and off while listening. Did you make the system better? Try the same experiment using the Rock Concert trend and play your favorite live album through your system this time. Over time, you'll begin to see what really constitutes a problem and what can be overlooked. You don't need to have access to a live venue to do this. Set your speakers up in your garage, or living room, or both and try to see the differences in the rooms.

## 10 StudioLive Series III Rack Mixer SD Recording

StudioLive Series III rack mixers are equipped with an onboard stereo SD recorder that allows you to record any mix as a stereo WAV file to any FAT16- formatted SD card or FAT32-formatted SDHC card.

This section explains how to use your stereo SD Recorder.

### 10.1 Recording a New Capture Session

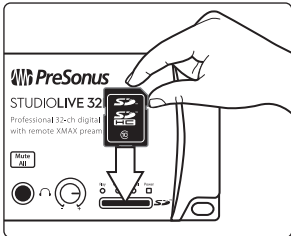

1. Insert a FAT16-formatted SD card or FAT32-formatted SDHC card into your StudioLive Series III rack mixer. An SD card will provide up to 2 GB of storage space. An SDHC card will provide up to 32 GB.



2. Launch UC Surface and click or tap on the Capture button.



3. Click or tap on the Create New Session icon.

4. You will be asked to name your session using the Artist Name, Venue, and Location. Once you have created a session after customizing any of these fields, UC Surface will save them for future use. So, for example, if you would like to create another session for an artist, you can click on the pull-down menu to the right of the customization field and simply select it from there.

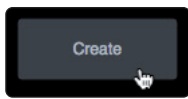
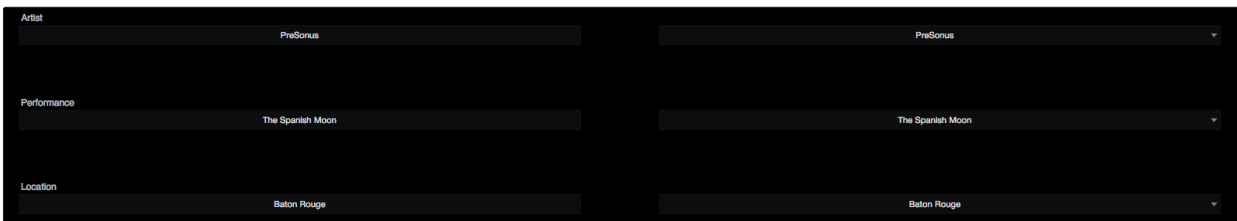

5. Click the Create button.

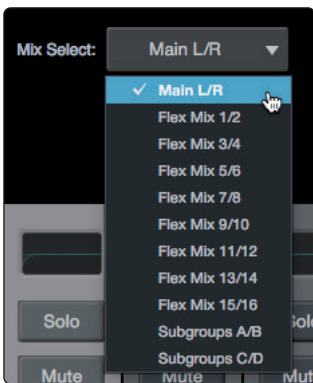

6. Select the mix you would like to record. By default, Capture will record the main mix.



7. Click record to begin.

## 10.2 Capture Screen

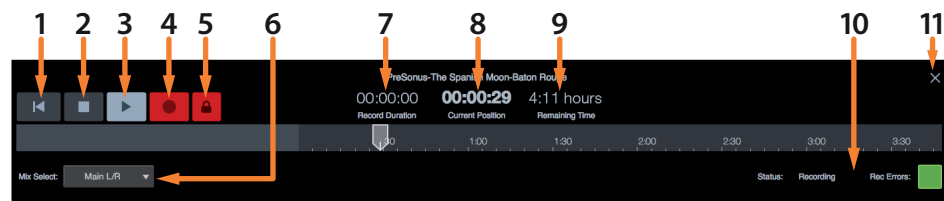

1. **Return to Zero.** Return playback position to the beginning of the session.
2. **Stop.** Stops recording or playback.
3. **Play.** Starts playback.
4. **Record.** Begins recording.
5. **Record Lock.** Prevents the recording from being stopped. Record Lock must be disabled before the recording can be stopped.
6. **Mix Select.** Drop-down menu to select stereo mix to be recorded.
7. **Recording Duration.** Displays how long the current Session has been recording.
8. **Current Position.** Displays the current timeline position of the playback cursor.
9. **Remaining Time.** Displays the remaining time that can be recorded, based on the size of the available storage left on the SD card.
10. **Recording Status Messages.** See Section 9.3 for more information.
11. **Close Session.** Closes current session and returns to the start screen.

## 10.3 Recording Status Indicators

At the lower right corner of the screen, you will see recording status indicators. These will help you to keep an eye on how well your recording session is going.

### 10.3.1 Status

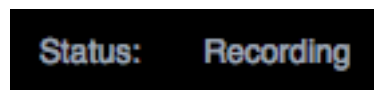

- **Ready.** SD Card session is loaded, is currently not busy, and is waiting for user input.
- **Recording.** Audio is being recorded to any Track(s) that are currently armed for recording.
- **Preparing...** The session is currently processing an action. This is commonly seen when attempting to play back a long session after it is first loaded or has just finished recording.
- **Playing.** The recorded session audio is currently being played back.



### 10.3.2 Recording Errors

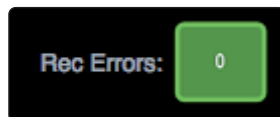

**Green.** The recording session currently has no recording errors, and there isn't a chance that an error will occur. The green box will display 0 inside, showing that there are currently no record errors.

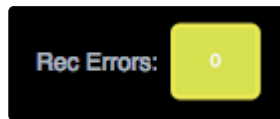

**Yellow.** The recording session currently has no record errors; however, the SD Card's read/write speed are being stretched to the limit. In this case, it is possible that recording errors can occur. The yellow box will display 0 inside, showing that there are currently no record errors.

*Note: As an SD Card's storage space is filled, its read/write speed slows down. Because of this, the Rec Errors indication may turn from green to yellow as the card fills up.*

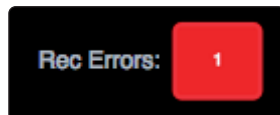

**Red.** As soon as a recording error occurs, this indication will turn red to alert you. The number of errors will be displayed in the box. When errors occur, you will hear a skip or a drop-out in the recorded audio.

*Power User Tip: As soon as you see an error display, make a note of the current timeline position. This will help you to isolate the audio dropout more easily.*

# Added bonus: PreSonus' previously Top Secret recipe for . . .

## Chicken and Andouille Gumbo

### Ingredients:

- 1 C All-Purpose flour
- ¾ C Vegetable Oil
- 1 large onion (diced)
- 1 small onion (quartered)
- 6 celery stalks (diced)
- 1 large green bell pepper (diced)
- 3 cloves garlic (2 minced, 1 whole)
- 1 lb link Andouille sausage
- 4 Chicken leg quarters
- 4 qt water
- 4 bay leaves
- 1 tsp thyme
- 1 tsp Old Bay seasoning
- 1-2 C frozen okra, sliced
- ¼ C fresh parsley, minced
- 6-8 eggs (optional)

### Cooking Instructions:

1. In a large pot, combine whole chicken leg quarters, water, quartered onion, Old Bay, 2 bay leaves and 1 whole clove garlic. Cover and bring to a low boil. Simmer stock until chicken is falling off the bone. Remove the chicken and set aside. Discard the onion, bay leaves, and garlic, reserving the liquid.
2. In a heavy saucepan, heat 1 Tbsp of the oil on medium high heat and brown the andouille until it is cooked through. Set aside sausage for later.
3. In the same saucepan, add and heat remaining oil. Slowly add flour 1-2 Tbsp at a time, stirring continuously. Continue cooking and stirring the roux until it is a dark brown (it should look like melted dark chocolate). Be careful to not to get the oil too hot or the flour will burn and you'll have to start over.
4. Once roux has reached the correct color, add diced onion, celery, green pepper, and minced garlic. Cook until vegetables are very tender. Do not cover.
5. Slowly add 1 quart of chicken broth and bring to a low boil, stirring constantly.
6. Transfer roux mixture to a soup pot and bring to low boil. Do not cover, the roux will settle on the bottom of the pot and burn.
7. Add remaining chicken broth, bay leaves, and thyme. Simmer for 30 minutes.
8. While gumbo is simmering, debone and shred chicken and slice the andouille.
9. Add chicken and andouille to gumbo and return to a simmer. Simmer for 30-45 minutes.
10. Stir in frozen okra and parsley and bring to a rolling boil.
11. **Optional:** Crack one egg into a teacup and quickly pour into the boiling gumbo. Repeat with the other eggs being careful not to cluster them too closely. After all the eggs have risen back to the surface, reduce heat and simmer.
12. Correct seasoning with salt and pepper (red, white and/or black) if necessary.
13. Serve over rice with potato salad.

### Serves 12

©2022 PreSonus Audio Electronics, Inc. All Rights Reserved. AudioBox USB, Capture, CoActual, EarMix, Eris, FaderPort, FireStudio, MixVerb, Notion, PreSonus, PreSonus AudioBox, QMix, RedLightDist, SampleOne, Sceptre, StudioLive, Temblor, Tricom, WorxAudio, and the Wave Logo are registered trademarks of PreSonus Audio Electronics, Inc. Studio One is a registered trademark of PreSonus Software Ltd.

Mac, macOS, iOS, and iPadOS are registered trademarks of Apple, Inc., in the U.S. and other countries. Windows is a registered trademark of Microsoft, Inc., in the U.S. and other countries.

ASIO is a trademark and software of Steinberg Media Technologies GmbH. VST is a trademark of Steinberg Media Technologies GmbH.

Bluetooth is a registered trademark of Bluetooth SIG. USB Type-C and USB-C are registered trademarks of USB Implementers Forum. SD Logo is a trademark of SD-3C, LLC. Dante is a registered trademark of Audinate. The terms HDMI, HDMI High-Definition

Multimedia Interface, and the HDMI Logo are trademarks or registered trademarks of HDMI Licensing Administrator, Inc. powerCON is a registered trademark of Neutrik, in the U.S. and other countries.

Other product names mentioned herein may be trademarks of their respective companies. All specifications subject to change without notice... except the recipe, which is a classic.



# UC Surface

## Software Reference Manual



# UC Surface



18011 Grand Bay Ct. • Baton Rouge,  
Louisiana 70809 USA • 1-225-216-7887  
[www.presonus.com](http://www.presonus.com)

Part# 70-62000084-B